





# Intellian

## t80W / t80Q

Installation and Operation User Guide

# General Precautions

Before you use the antenna, make sure that you have read and understood all safety requirements.

	<p><b>THIS WAY UP</b></p> <ul style="list-style-type: none"><li>Place the boxes/crates on the floor noting the direction of the arrow.</li></ul>
	<p><b>FRAGILE</b></p> <ul style="list-style-type: none"><li>Since the Radome is fragile, handle it with care. Do not apply excessive pressure or shock. These may cause surface cracking or other damage.</li></ul>
	<p><b>DO NOT STACK</b></p> <ul style="list-style-type: none"><li>Do not stack boxes/crates as there is a risk boxes/crates may fall and be damaged.</li></ul>
	<p><b>KEEP DRY</b></p> <ul style="list-style-type: none"><li>Always make sure the antenna is stored on a dry surface in a dry, well-ventilated area.</li><li>The antenna is designed to withstand a normal rain shower; however, water resistance cannot be guaranteed if the antenna is submerged.</li></ul>

\* **DO NOT SHIP VIA RAIL:** Ensure not to ship any system via Rail.

\* **DO NOT STORE THE ANTENNA WRAPPED IN A TARP, TENT, VINYL, AND OTHERS:**

To avoid damage to radome paint, do not use a cover on the radome. Using any type of cover may cause paint damage. Intellian radomes are designed to withstand exposure to rain, humidity, and sun/UV rays when assembled according to Intellian instructions, and when the supplied approved hardware and sealants are used. Under no circumstances should an Intellian radome be covered by any protective covering that adheres, bonds, or clings to the surface, whether by self-adhesion or tension.

## Serial number of the product

This serial number will be required for the all troubleshooting or service inquiries.

# Intellian

© 2021 Intellian Technologies Inc. All rights reserved.

Intellian and the Intellian logo are trademarks of Intellian Technologies, Inc., registered in the U.S. and other countries. t80W and t80Q are trademarks of Intellian Technologies, Inc. Intellian may have patents, patent applications, trademarks, copyrights, or other intellectual property rights covering subject matter in this document. Except as expressly provided in any written license agreement from Intellian, the furnishing of this document does not give you any license to these patents, trademarks, copyrights, or other intellectual property. All other logos, trademarks, and registered trademarks are the property of their respective owners. Information in this document is subject to change without notice. Every effort has been made to ensure that the information in this manual is accurate. Intellian is not responsible for printing or clerical errors.

### Disclaimer

The information in this user manual is subject to change without prior notice through a product life cycle. A printed version of the user manual is periodically updated and may contain inaccuracies or omissions compared to the recent product information. The most up-to-date information is available on our website at <https://www.intelliantech.com>.

# INDEX

---

<b>INTRODUCTION</b>	<b>9</b>
Intellian t80W/t80Q Introduction	10
Intellian t80W/t80Q Features	11
<b>INSTALLING THE ANTENNA</b>	<b>13</b>
System Package	14
Planning the Installation	18
Antenna Installation	22
<b>INSTALLING THE ACU</b>	<b>33</b>
Mounting the ACU	34
Connecting the System Cables	36
PC to ACU Communication Setup	41
Wi-Fi Connection	43
<b>OPERATING THE ACU</b>	<b>47</b>
Introduction	48
Normal mode	49
Setup mode	53
Installation Settings	56
Antenna Settings	59
Satellite Settings	70
System Settings	77
<b>Aptus®</b>	<b>83</b>
Introduction to Aptus®	84
Software Installation	85
PC to ACU Communication Setup	86
Toolbar Menus	89
System Property Status Dashboard	92
Work View Tabs	94
<b>APTUS WEB</b>	<b>111</b>
Introduction	112
Main Page	113
Antenna Settings	117
Firmware & Configuration	123
Administration	129
<b>TECHNICAL SPECIFICATION</b>	<b>139</b>
<b>WARRANTY</b>	<b>140</b>
<b>APPENDIX: LIBRARY UPGRADE GUIDE</b>	<b>141</b>

---

# CERTIFICATIONS



## CE & FCC Declaration of Conformity (DoC)

We, Intellian Technologies, Inc. located at 2F Dongik Bldg., 98 Nonhyun-dong, Kangnam-gu, Seoul 135-080, Korea declare under our sole responsibility that the product(s) described in the below to which this declaration relates is in conformity with the requirements of the EU EMC Directive 89/336/EEC and FCC 47 CFR Part 15 Subpart B when the methods, as described in EN 60945: 2002, ANSI 63.4: 2003 and EN 60950-1:2006+A11:2009+A1:2010+A12:2011, respectively.

### Product Information:

<b>Product Name(s):</b>	Intellian t80, 85cm Ku-band Maritime TVRO Antenna System Intellian t100, 105cm Ku-band Maritime TVRO Antenna System Intellian t110, 105cm Ku-band Maritime TVRO Antenna System Intellian t130, 125cm Ku-band Maritime TVRO Antenna System
<b>Model Number(s):</b>	T3-9XXX, T3-10XXX, T3-11XXX, T3-13XXX

### Supplementary Information:

<b>Notified Body Involved: (Testing Organization)</b>	SK Tech Co., Ltd. 820-2, Wolmoon-Ri, Wabu-Up, Namyangju-Si, Kyunggi-Do, 473-905, Korea
<b>Technical/Compliance File Held by:</b>	Intellian Technologies, Inc. 348-5 Chunggho-Ri, Jinwi-Myeon, Pyeongtaek-Si, Gyeonggi-Do, 451-862 Korea

**Authority:** Kevin Eom  
/ CTO, R&D

**Signature:** 

**Date:** 21<sup>st</sup> August, 2014







# INTRODUCTION

**Intellian t80W/t80Q Introduction**

**Intellian t80W/t80Q Features**

## Intellian t80W/t80Q Introduction

The t-Series is designed completely in-house, 3-axis stabilized platform available both an Intellian exclusive WorldView™ Low Noise Block down converter (LNB) module and General-purpose Universal Quad LNB.

The t-series offers recreational and commercial boaters to achieve a new level of satellite TV convenience, as well as unparalleled access to the greatest number of channels at sea.

The Intellian t80W is the TV antenna capable of operating in all global market without the need of changing the LNB unit inside of antenna's dome.

The Intellian t80Q has the European dedicated linear LNB and provides higher optimized gain for especially European waters.

Intellian's patented WRS (Wide Range Search) algorithm achieves fast signal acquisition and pioneering DBT (Dynamic Beam Tilting) technology makes keeping stable signal locking.

Designed to excel in all sea states and weather conditions, t80W and t80Q are tested to industry-leading standards for vibration and resonance frequency as well as extreme.

## Intellian t80W/t80Q Features

### **Global Satellite Services Compatibility**

Intellian t80W provides boaters with seamless and uninterrupted satellite TV service across multiple coverage areas and service providers offering cost-effective solutions and straightforward, simple operation from the Americas (circular polarized), as well as Europe, the Middle East and the Asia-Pacific region (linear polarized) with one LNB module.

### **Hands-Free WorldView™ LNB Module for t80W**

The WorldView™ LNB module is built with the precise pioneering technology of  $\pm 25$  kHz ( $\pm 2.5$ ppm) stability and is designed to receive multi-band and multi-polarization satellite TV services around the globe. Therefore, boaters are no longer required to manually switch out the LNB inside the antenna dome or re-wire the system when the vessel travels from region to region.

### **Universal Quad LNB Module for t80Q**

The Universal Quad LNB module is optimized for European waters using by Dual Local Frequency (9.75GHz, 10.60GHz). It provides higher optimized gain for especially European water.

### **DVB-S2 Digital TV Receptions**

Some of the HD TV services have moved to DVB-S2 transmission formats and there will be more in the future. Thanks to Intellian's groundbreaking DVB-S2 digital TV technology, now boaters are able to enjoy their favorite Sat TV entertainment at sea, just like home.

### **Wide Elevation Range**

The wide elevation range enables the antenna to have seamless signal reception while the vessel is traveling near the Equator or Polar Regions.

### **Global Satellite Library**

The t80W includes the pre-programmed global satellite library which allows the boaters to select the desired satellite while traveling from region to region. Once the satellite is selected the WorldView™ LNB module will automatically switch to the corresponding local frequency to receive the signal.

The t80Q has its own optimized library for universal LNB (Local Frequency: 9.75GHz/10.6GHz).

### **Dedicated Management Ethernet Port**

The Management Ethernet Port on the front of the ACU enables direct and simple network connection between a PC and the ACU. The management Port supports DHCP network connection by default, allowing automatic IP configurations and quick access to Intellian's remote management solution, the Aptus Web software.

### **Wireless Connectivity and Intellian App**

The built-in Wi-Fi enables the ACU to be wirelessly connected and can be turned on or off. Any kind of wireless devices such as PCs, laptops, and smartphones can be used to connect to the ACU and monitor, control and change the settings of the system wirelessly. An Intellian App is available for download to access to the ACU via Wi-Fi and operate the antenna from iPhone, iPad or other network devices. iPhone and iPad are registered trademarks of Apple Inc.

### **Intellian Network Devices**

Intellian Aptus Web enables connection to the antenna to monitor the real-time status of the connected system. This function provides users with the direct connection to sibling devices allowing an integrated control solution for linking multiple devices.

**NOTE:** The figures provided in this manual are based on the t80W model, but the functions and operation of the models (t80W, t80Q) are the same. The dedicated functions of the t80Q model are detailed separately.

# INSTALLING THE ANTENNA

## **System Package**

Antenna Unit

ACU (Antenna Control Unit)

Installation Kit

## **Planning the Installation**

Selection of Antenna Installation Site

System Cables

RF Cable (Customer supplied)

Power Requirement

Gyrocompass / GPS Interface Cable (Customer supplied)

Tools required for Installation

## **Antenna Installation**

Unpacking the Package Box

Antenna Dimensions

Antenna Mounting Hole Pattern

Installing the System Cables

Mounting the Radome

RF Cable Connections

Reinstall the top radome

Position the Radome

## System Package

The Intellian t80W/t80Q consists of two major units, an antenna unit and the antenna control unit (ACU).

### Antenna Unit

The antenna unit includes an antenna pedestal inside a radome assembly unit. The pedestal consists of the satellite antenna main dish and sub-reflector module with the WorldView™ LNB module(t80W) and the Universal Quad LNB module(t80Q) mounted on a stabilized pedestal.

The radome protects the antenna pedestal assembly unit from the severe marine environment.

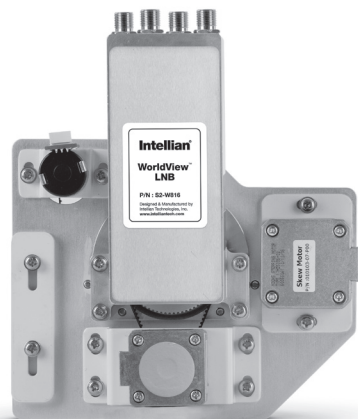

WorldView™ LNB module  
(For t80W model)

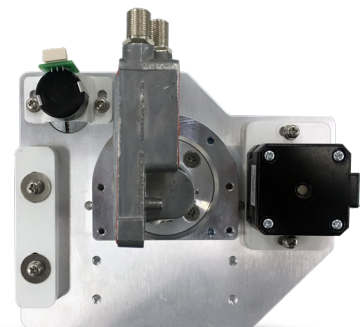

Universal Quad LNB module  
(For t80Q model)

**ACU (Antenna Control Unit)**

Antenna Control Unit (ACU) provides the power to the antenna and controls the various settings of the antenna. Additionally, VFD (Vacuum Fluorescent Display) allows you to operate the ACU in the dark.

Front panel









Rear panel

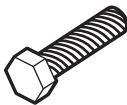

**Installation Kit**

Contains the items required for mounting the antenna unit and ACU to the vessel.

Antenna	Q'ty	Description	Size	Remark
	5	Hex. Bolt	M12 x 80L	
	5	Flat Washer	M12	
	5	Spring Washer	M12	Antenna-Deck
	10	Hex. Nut	M12	

ACU	Q'ty	Description	Size	Remark
	5	Self-Tapping Screw	ø 4 x 16	Table Mount Bracket
	10	Flat Head Screw	M4 x 12L	Rack Mount Bracket ACU
	5	Sems Bolt	M3 x 12L	Table Mount Bracket ACU

**Other Components**

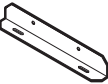

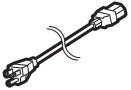

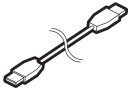

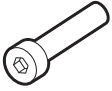





	Image	Q'ty	Description	Size	Remark
1		2	Rack	-	ACU-19inch Rack
		2	ACU Bracket	-	ACU-Table
2		1	RG6 Cable (Optional)	30m	ANT - ACU RF Cable
3		1	RG6 Cable	3m	ACU - IRD Cable
4		1	AC Power Cable (CEE 7/7)	1.5m	ACU Power
5		1	PC Serial Cable	1.8m	ACU to PC
6		1	USB Cable (A-A)	1.8m	ACU to PC



	Image	Q'ty	Description	Size	Remark
7		2	Rubber Gland	RG6	RG6 Cable-Antenna
8		5	Hex Socket Head Cap	M6 x 40L	Radome (Top-Bottom)
9		5	Spring Washer	M6	Radome (Top-Bottom)
10		5	Flat Washer	M6	Radome (Top-Bottom)
11		1	Wi-Fi Antenna	110mm	-
12		1	USB Flash Drive		-
13		1	Mounting Template	-	-
14		1	Quick Installation Guide	-	-

## Planning the Installation

### Selection of Antenna Installation Site

Install the antenna in accordance with the following procedures to insure maximum performance of the antenna.

The antenna should be installed in a place where there is all round clear view of the horizon. Please be sure there are no obstacles within 15 degrees above the antenna. Any obstacles can prevent the antenna from tracking the satellite signal (Refer to the drawing).

Do not install the antenna near by the radar especially on the same plane as the microwave radar transmissions as these will overload the antenna front-end circuits. It is recommended to position the antenna at least 4 feet (1.2m) above or below the level of the radar and minimum of 15 feet (4.6m) away from any high power short wave radars.

The mounting platform should be robust enough and not subject to excessive vibration. The movement of the antenna can be minimized by installing at the center of the vessel. For optimal performance of the antenna, it is not recommended to install on any corner of the vessel, where the movement of the vessel is the greatest. Install the bottom of the antenna parallel to the surface of the sea and fix tightly to the structure of the vessel.

Elevation Limit  
of Obstacles

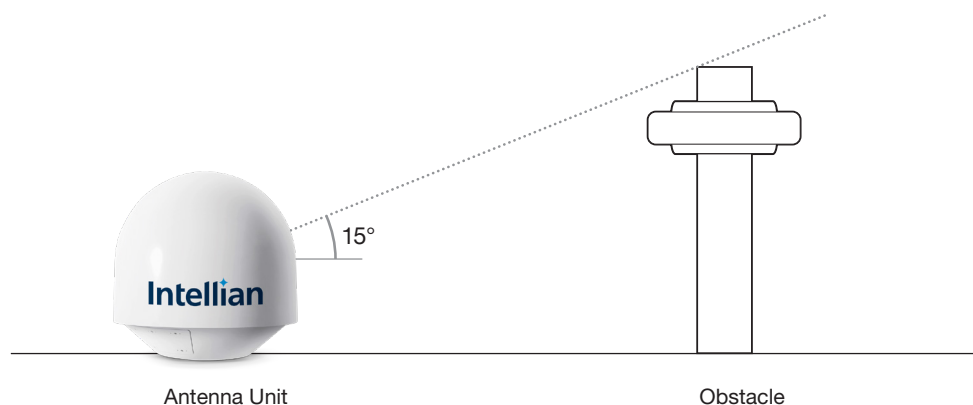

**System Cables**

Before installing the system cables, you need to take the following points into consideration.

1. All cables need to be well clamped and protected from physical damage and exposure to heat and humidity.
2. Cable with a tight bend radius should be avoided.
3. Where a cable passes through an exposed bulkhead or deck head, a watertight gland or swan neck tube should be used.

**RF Cable (Customer supplied)**

Due to the signal losses across the length of the RF coax on L-Band, Intellian recommends the following 75 ohm coax cable types for standard system installations. For cables that run longer than 100 meters, please consult Intellian Technologies.

Run Length	Coax Type
Up to 35 meters	RG6 or LMR-300-75
Up to 60 meters	RG11 or LMR-400-75
Up to 100 meters	LMR-600-75

**Power Requirement**

Intellian t80W/t80Q has been designed to work on a vessel's power supply rated at 110-220 V AC.

**Gyrocompass / GPS Interface Cable (Customer supplied)**

Type	Multi-conductor, Shielded
Number of wires	2 conductors for NMEA 0183, 5 conductors for NMEA 2000

• NMEA 0183 Connector

Pin	Signal
-	NMEA 0183 -
+	NMEA 0183 +

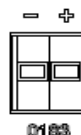

• GPS Connector

Pin	Signal
1	GND
2	GPS OUT A
3	N/C
4	N/C
5	GPS_IN
6	GPS_OUT B
7	N/C
8	N/C
9	GPS_GND

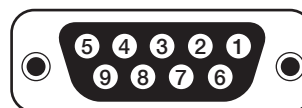

ACU GPS In/Out Port  
D-Sub 9 pin Female

• NMEA 2000 Connector

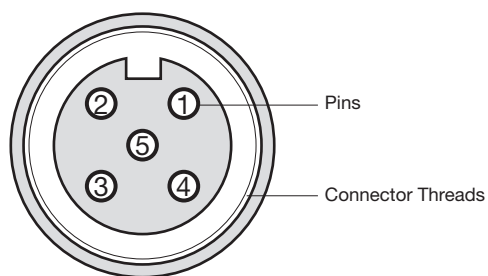

Male Connector

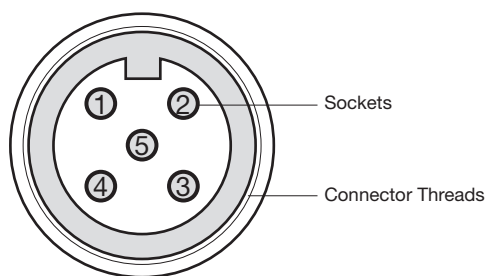

Female Connector

Pin	Signal
1	Shield
2	NET-S, (power supply positive, +V)
3	NET-C, (power supply common, -V)
4	NET-H, (CAN-H)
5	NET-L, (CAN-L)

Pin	Signal
1	Shield
2	NET-S, (power supply positive, +V)
3	NET-C, (power supply common, -V)
4	NET-H, (CAN-H)
5	NET-L, (CAN-L)

**Tools required for Installation**

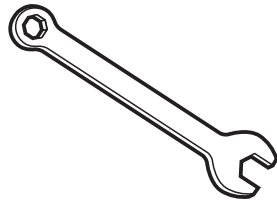

11 mm Spanner

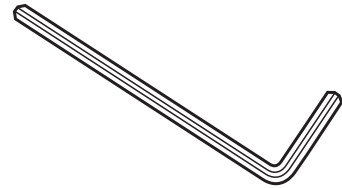

5 mm Allen/Hex key

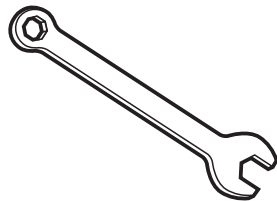

13 mm Spanner

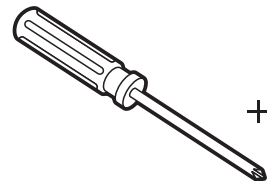

Cross Head Screwdriver

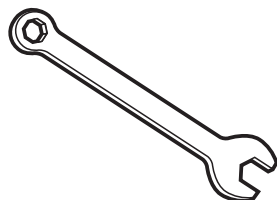

19 mm Spanner

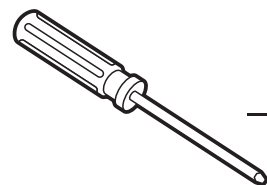

Flat Head Screwdriver

## Antenna Installation

### Unpacking the Package Box

**Step 1.**  
Remove the top panel.

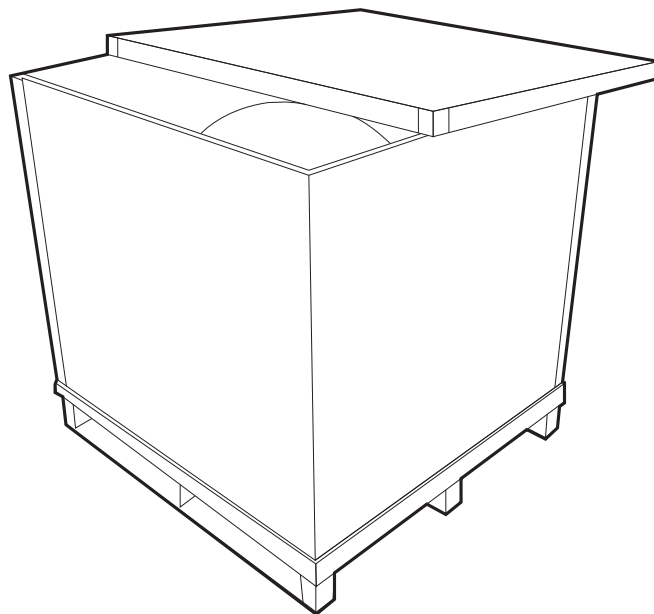

**Step 2.**  
Remove ACU box and installation kit box.

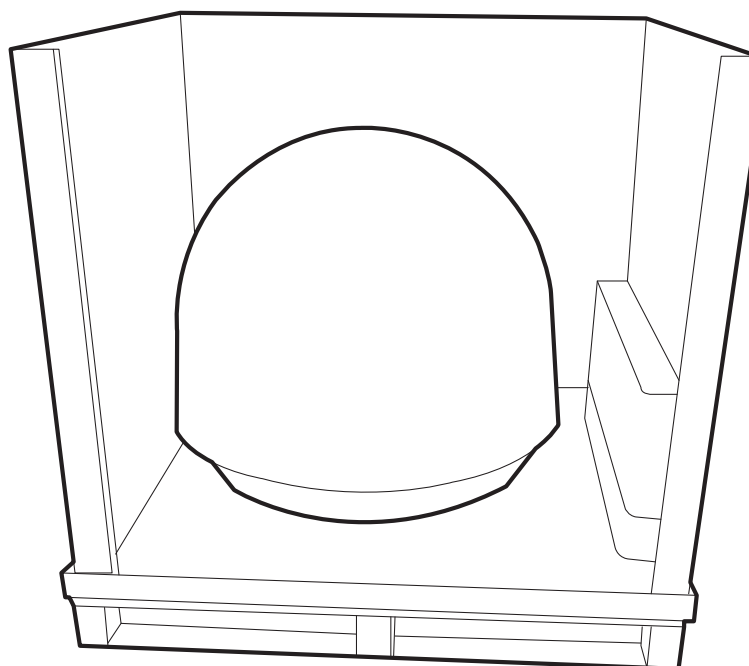

**Step 3.**

Remove the 4 shipping bolts that mount the antenna to the pallet.

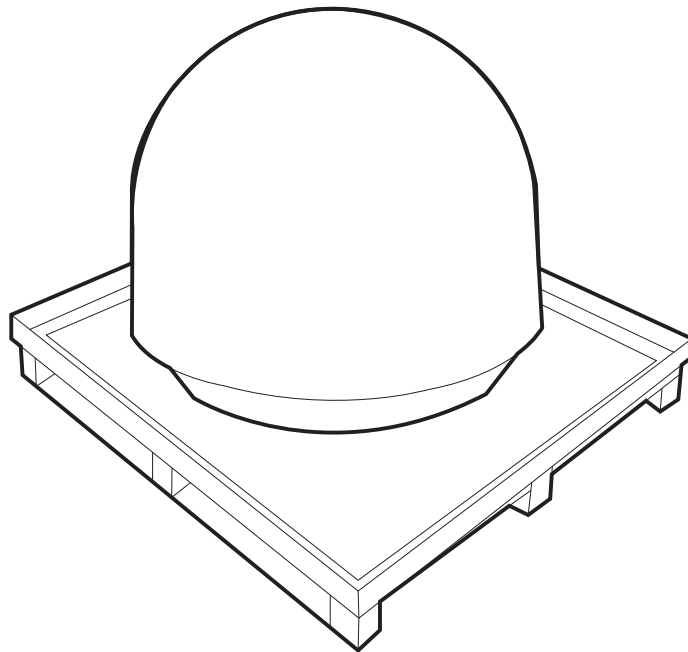

**WARNING:** When lifting the antenna by using the lifting strap, ensure to disassemble the antenna and the pallet.

**Step 4.**

Open the top radome and remove the red shipping restraints (3 fixing brackets mounted to the antenna pedestal and the azimuth axis).

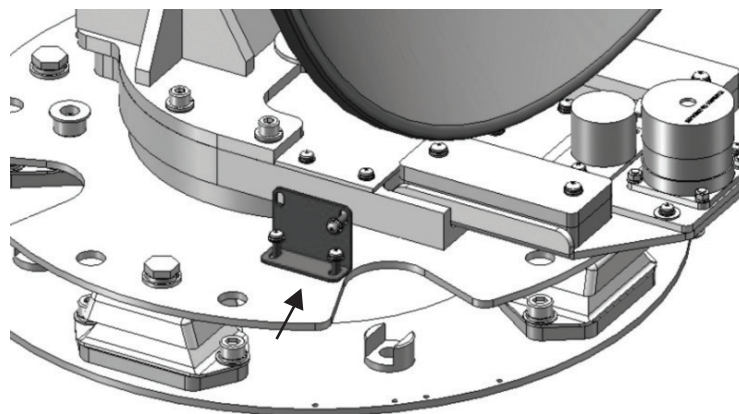
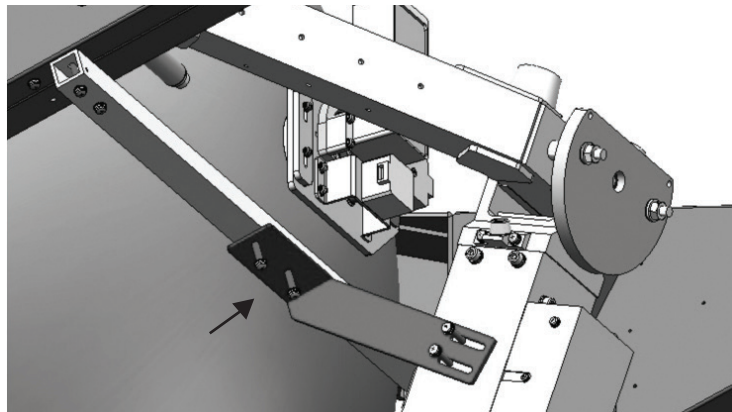
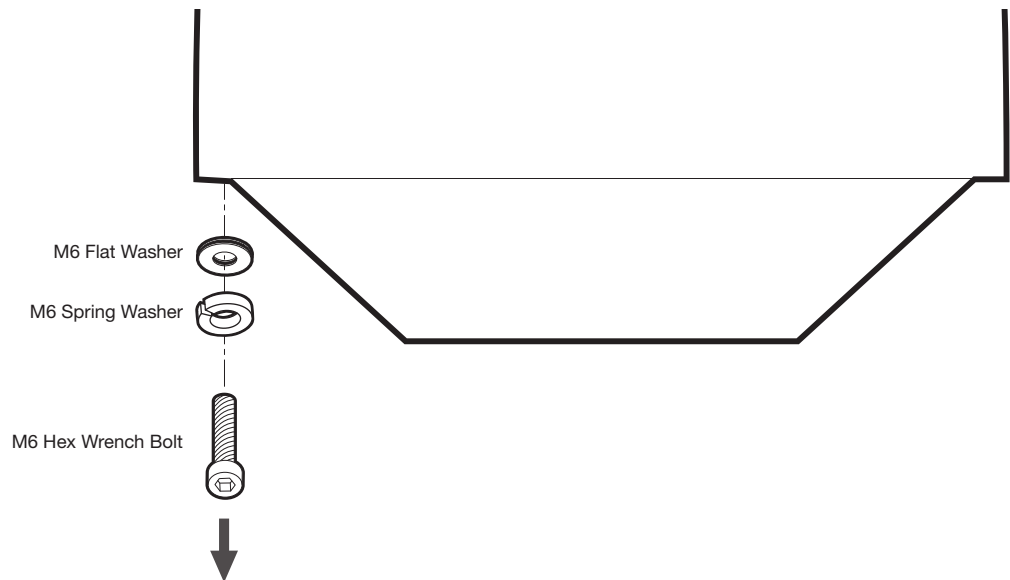

**NOTE:** The pictures provided are t80W, but the description is the same for both t80W and t80Q.



**Antenna Dimensions**

The method of installation and mounting of antenna may vary with vessel design but the following procedures are applicable in most situations, and will result in a secure and effective installation. Confirm the height and diameter of the antenna before installing it.

Radome Dimensions

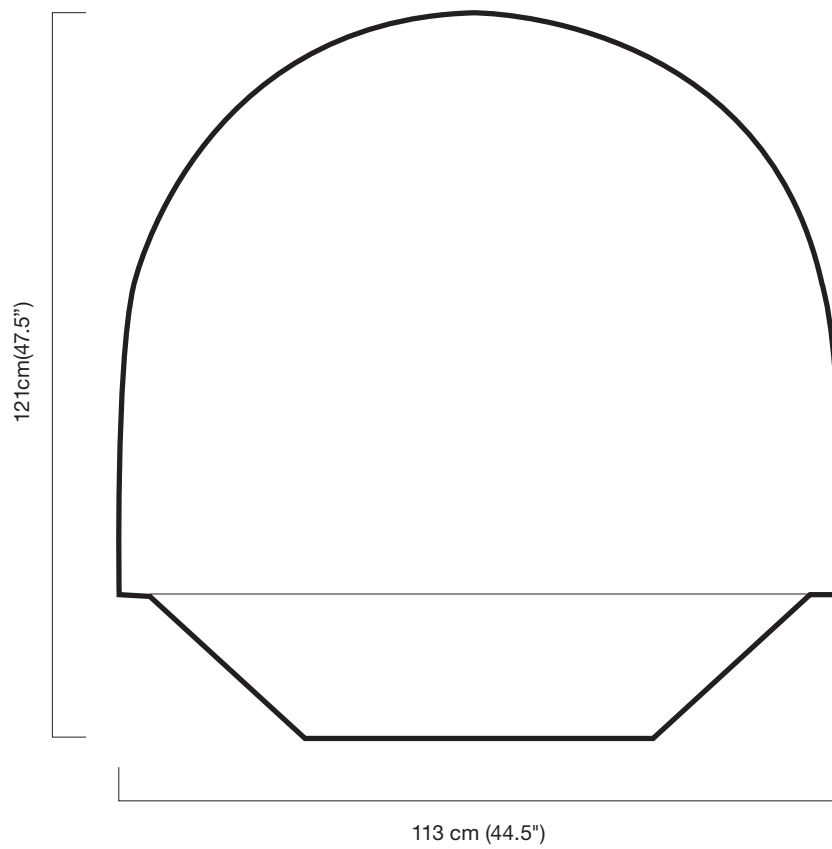

### Antenna Mounting Hole Pattern

Use the supplied mounting template when drilling mounting holes on the mast. The hole placement for the antenna must match the mounting hole pattern on the template.



**WARNING**

**WARNING:** When reusing an existing mast, check the condition of holes on the mast and make sure those are proper to use compared to the hole locations and sizes printed on the mounting template.

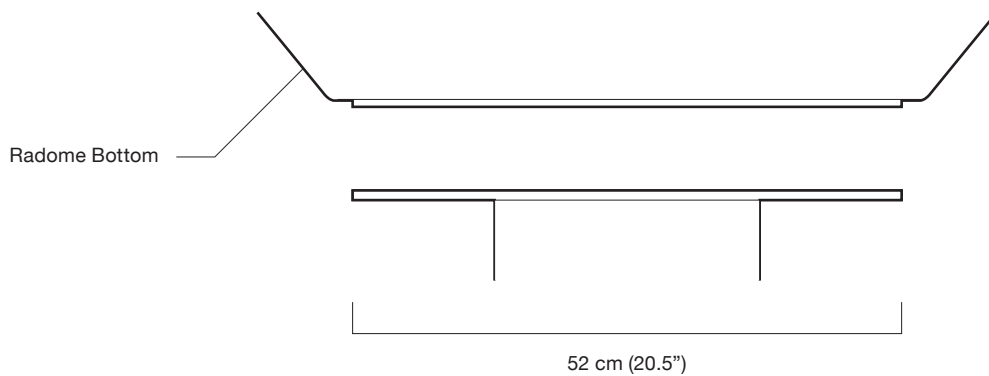
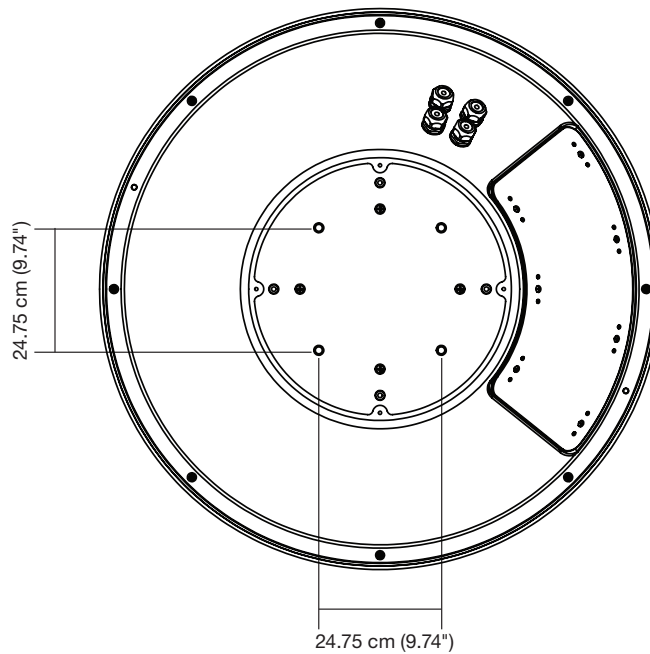

# Intellian

Antenna Mounting Hole Template

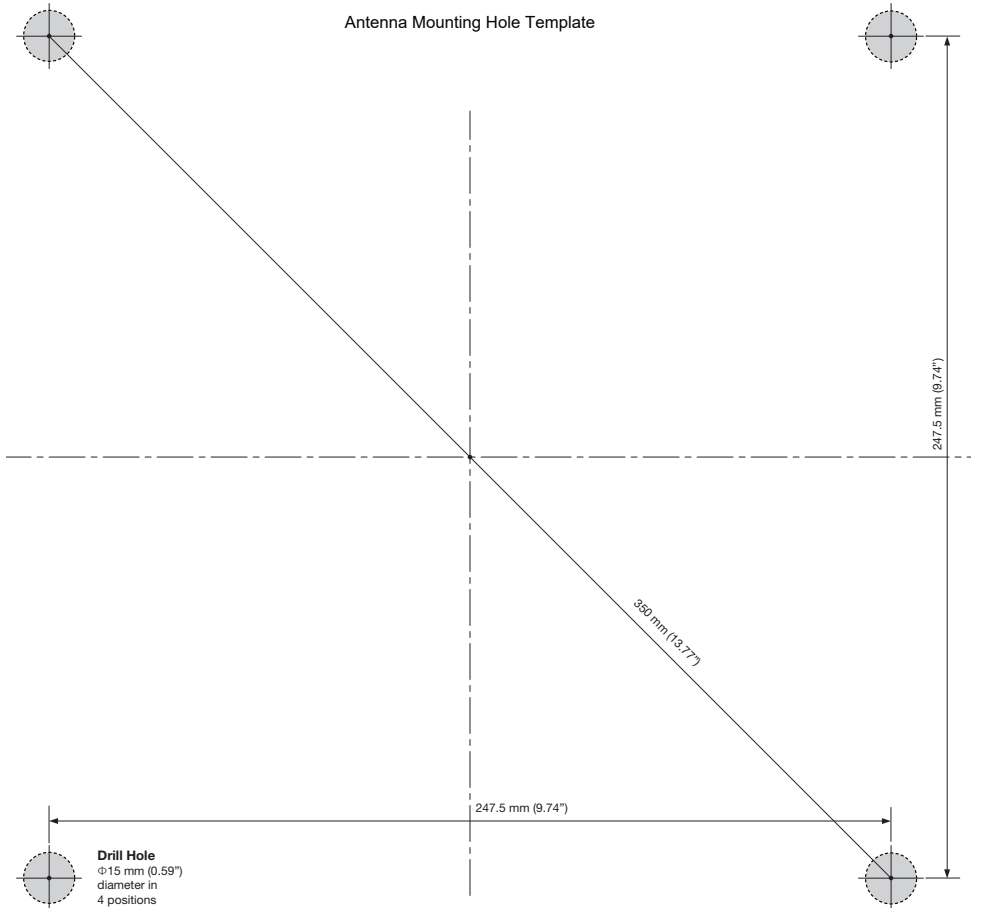

**Installing the System Cables**

The cables must be routed from the antenna through the deck and through various space on the ship to the antenna control unit. When pulling the cables in place, avoid sharp bends, kinking, and the use of excessive force.

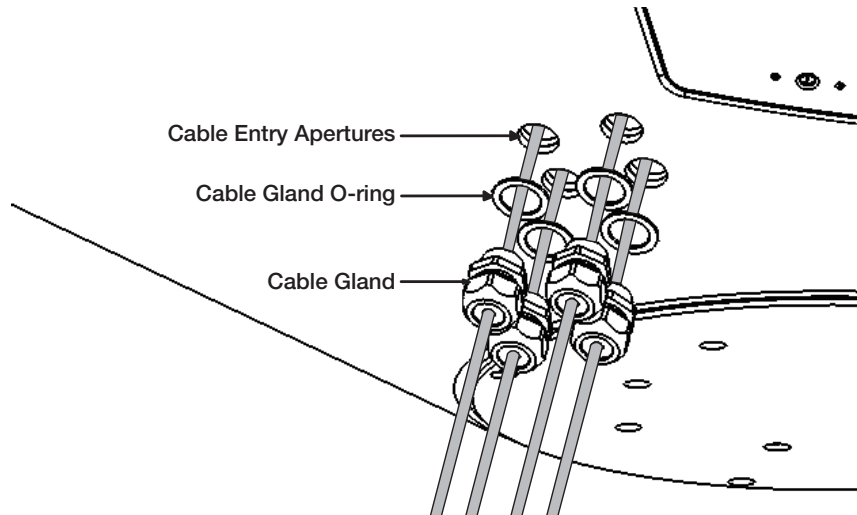

**NOTE:** To prevent cable damage, first pass the RF cables through the cable entry apertures into the radome, then connect the RF cables to the cable connectors on the inside of the radome.

**Mounting the Radome**

Bolt the radome base directly to the support pedestal. Make sure to use the Intellian supplied bolts from the accessory box when you mount the radome.

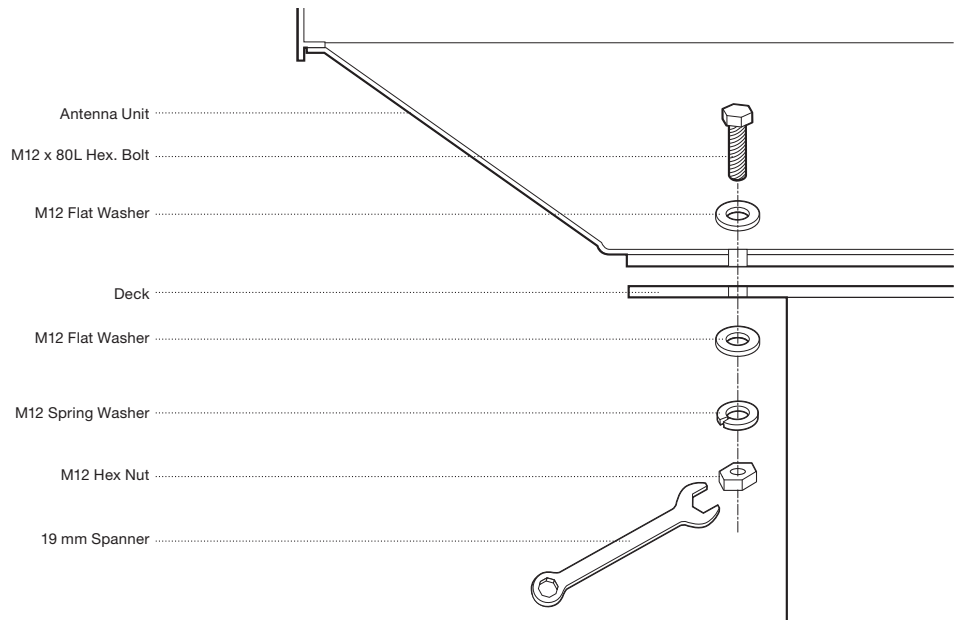

### RF Cable Connections

Before installing the RF cable, ensure that the RF cable labeled with RF1 is properly connected between the antenna control unit and the power switch box. Connect the 4 RF cables to the RF connectors using an 11mm spanner. Ensure that the power switch is off during the installation period. When all the hardware and cables have been installed, turn on the power switch. After connecting the RF cables, adjust the cable length then fix the cables on the cable tie holders by using cable ties.

### Inside Radome View

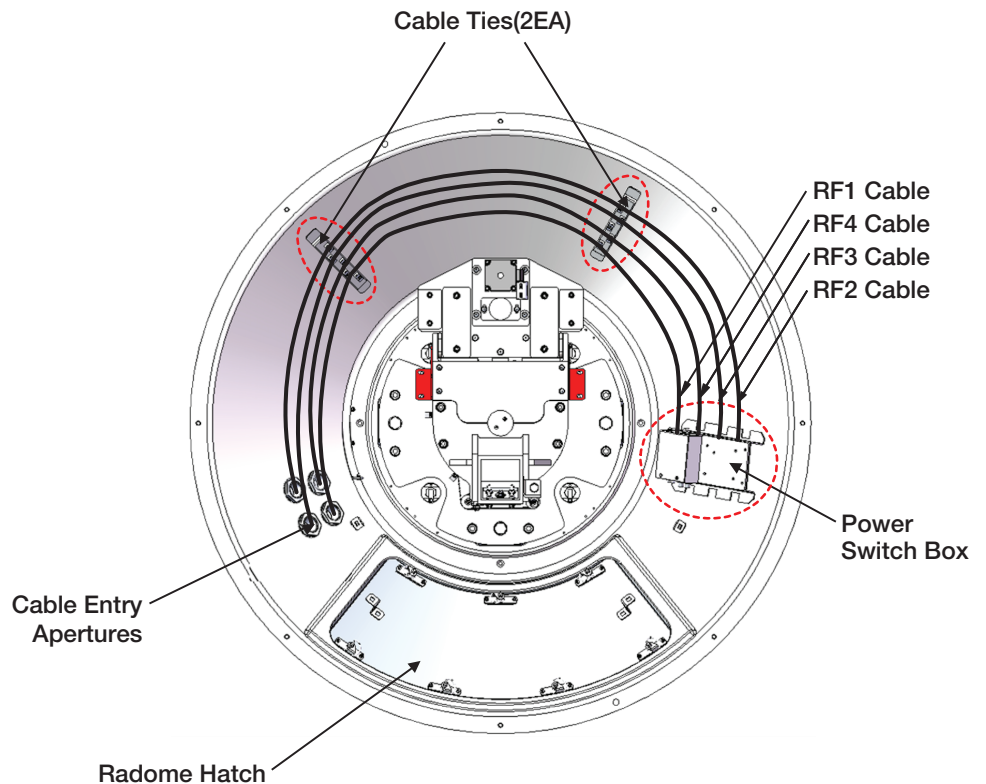

### Cable connection of Power Switch Box

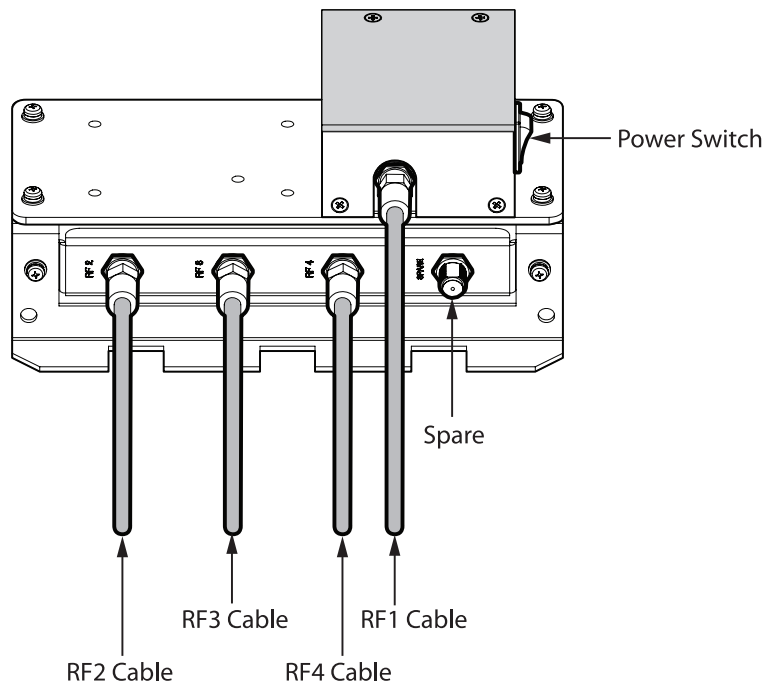

**NOTE:** There are 4 RF connectors on the power box. Be sure to connect each cable to its corresponding RF connectors.

Reinstall the top radome

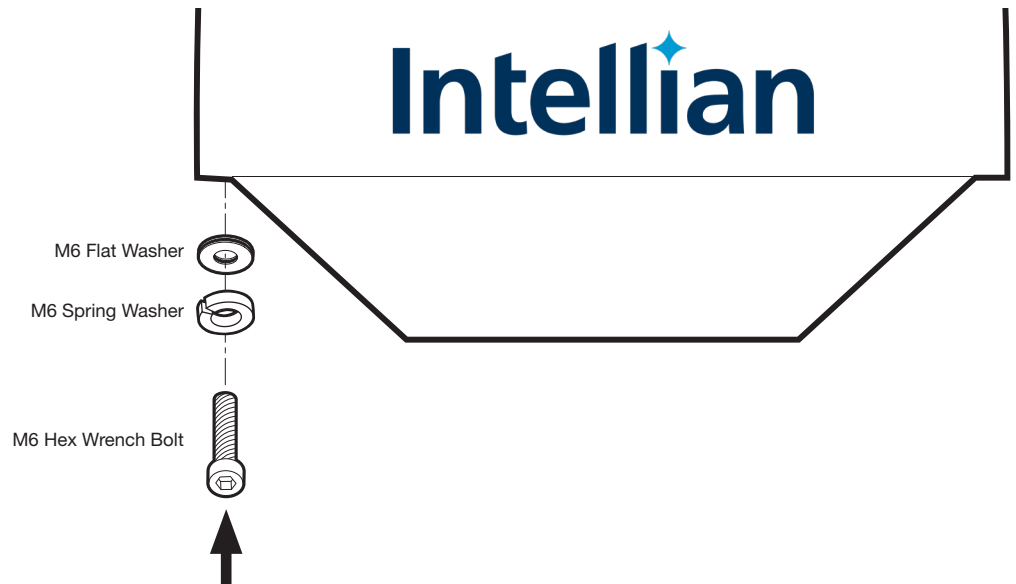

**Note:** Make sure to use the Intellian supplied bolts from the accessory box when you reinstall the top radome. Apply Loctite #262 or equivalent to the bolt thread, and fasten it to a torque setting of 3.5Nm.



**WARNING:** Please ensure that your Intellian system is ALWAYS powered ON upon leaving the dock. Failure to follow these instructions could result in damaging mechanical parts in the antenna and/or possibly void your warranty. Intellian strongly recommends to restrain the antenna pedestal properly while underway when power is removed from the antenna. The normal operating condition is to remain powered up at all times.

### Position the Radome

Position the antenna with the BOW direction parallel to the center line of the ship.

Recommended size of the support pedestal

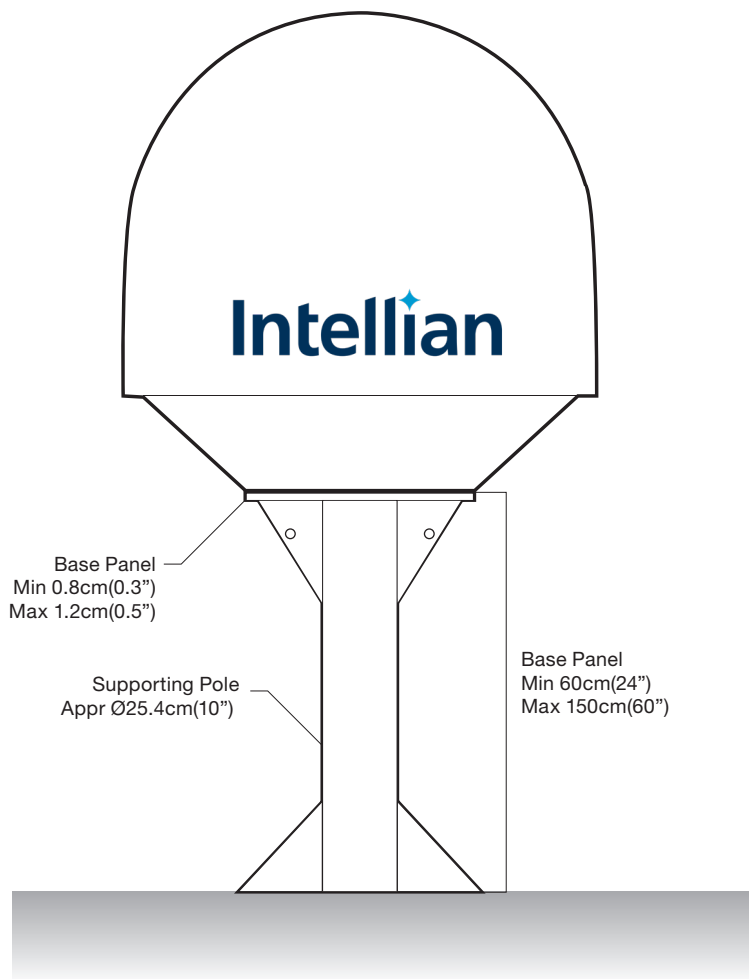



# INSTALLING THE ACU

## Mounting the ACU

19" Rack Mount Type

Table Mount Type

ACU Dimensions

Selection of ACU Installation Site

## Connecting the System Cables

Multi-Switch Connection

Receivers Direct Connection

Gyrocompass Connection

Connecting the System without a Ship's Gyrocompass

## PC to ACU Communication Setup

TCP/IP Connection

Serial/USB Connection

## Wi-Fi Connection

Setup Wi-Fi Connection

Setting up the PC in order to access Wi-Fi

## Mounting ACU

Intellian supplies two types of mounting methods 19" Rack Mount Type and Table Mount Type to mount your ACU.

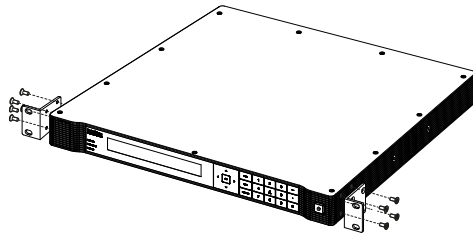

Figure 01. 19" Rack Mount Type

### 19" Rack Mount Type

- The ACU should be installed using the two supplied Rack Mounting Brackets which allow for a side 19" rack mounting configuration.
- Using the Flat Head Screw supplied, attach the mounting brackets to the sides of the ACU.
- Place the ACU in the location where it is going to be installed.
- Connect the cables to the rear of the ACU.

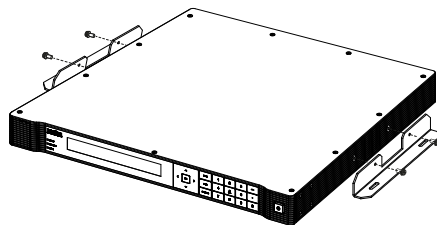

Figure 02. Table Mount Type

### Table Mount Type

- The ACU should be installed using the two supplied Table Mounting Brackets which allow for a top or bottom mounting configuration.
- Using the Sems Bolt supplied, attach the mounting brackets to the sides of the ACU.
- Place the ACU in the location where it is going to be installed.
- Using a pencil to mark the 4 hole positions (2 each side), and use the appropriate drill bit to screw down the brackets.
- Connect the cables to the rear of the ACU.



**WARNING**

**WARNING:** Ensure that the cables connected to the ACU are long enough to prevent damage when the ACU is pulled out from the rack.

**ACU Dimensions**

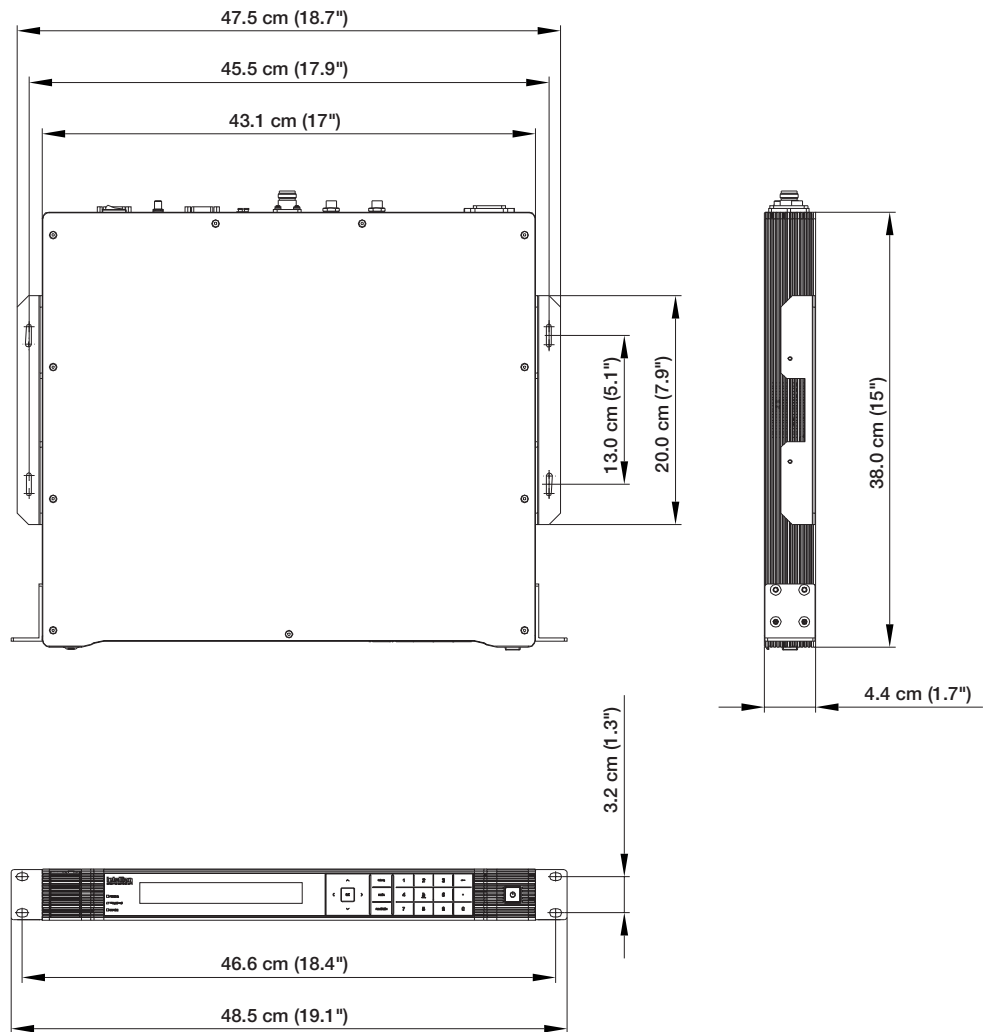

Figure 03. Dimension of ACU

**Selection of ACU Installation Site**

- The ACU should be installed below deck, in a location that is:
- Dry, cool, and ventilated.
- Easy accessible from your main TV viewing area.

## Connecting the System Cables

The t80W is capable of receiving multiband and multi-polarization satellite TV service around the globe using the Intellian WorldView™ LNB module.

The t80Q is optimized for European waters using by Universal Quad LNB has two LO(9.75GHz, 10.6GHz) and the Universal Quad LNB module. It provides higher optimized gain for especially European water.

### Multi-Switch Connection

When you use the multi-switch in single LNB mode, you need to connect RF1 and RF2 to the low-band (Horizontal Low and Vertical Low) outputs of the 4x8 multi-switch and disable DisEqC function while connecting to a receiver other than a European receiver. In Universal LNB mode, RF1~ RF4 can be connected to any 4 outputs of 4x8 multi-switch. However when you use the system for single LNB mode, RF3 and RF4 ports will not transfer the RF signal.

RF1	RF2	RF3/RF4	
13V	18V	13V+22kHz	18V+22kHz
<b>Vertical Low</b>	<b>Horizontal Low</b>	Vertical High	Horizontal High

**NOTE:** Intellian recommends connecting cables per the following configuration. If you require a different configuration, contact the Intellian's service team for additional assistance.

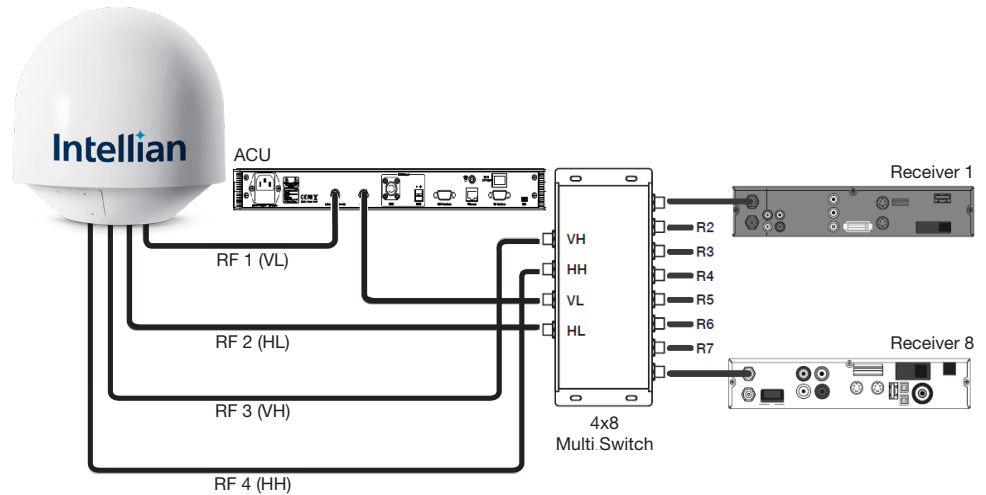

Figure 04. Multi-Switch Connection Configuration

- Connect the RF cable from the ACU's RF1 connector on the power switch box located inside of the radome to the ANT. RF1 connector on the rear of the ACU.
- Connect the RF cable from the RECEIVER's connector on the rear of the ACU to the RF on the IRD through the Multi-switch as shown figure above.
- Connect the ship's gyro cable from the ship's gyro to the Ship's Gyro connector on the ACU.
- Connect the power cable from the AC power connector on the rear of the ACU to a power source at 110- 220 V AC.
- Press the POWER ON switch on the rear of the ACU to power on the antenna.

### Receivers Direct Connection

In Universal LNB mode, RF1, RF2, RF3 and RF4 can be connected, however, when you switch and use the system from universal LNB mode (ex. Europe) to single LNB mode (ex. US), RF3 and RF4 will not work and only RF1 and RF2 will transfer the satellite's signal.

When connecting more than 4 receivers, refer to the previous section "Multi-Switch Connection" for more details.

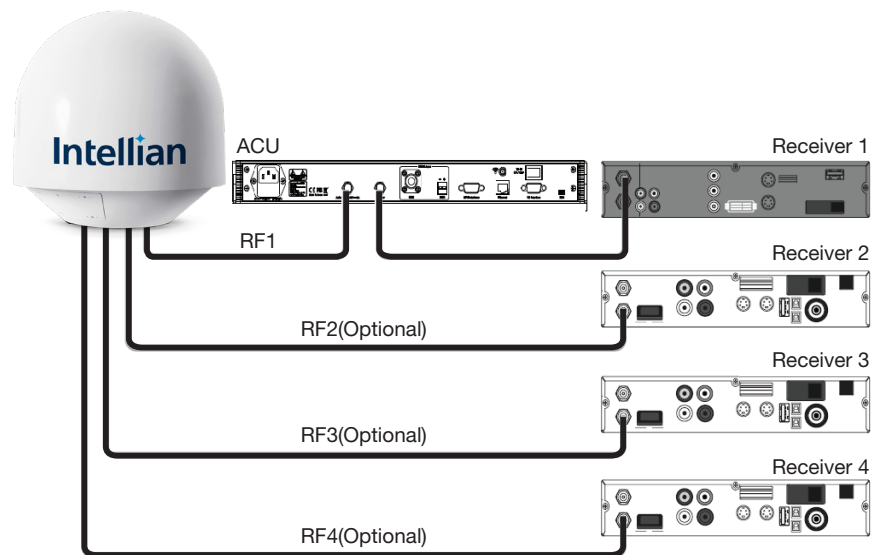

Figure 05. Receivers Direct Connection Configuration

- Connect the RF cable from the ACU's RF1 connector on the power switch box located inside of the radome to the ANT. RF1 connector on the rear of the ACU.
- Connect the RF cable from the RECEIVER's connector on the rear of the ACU to the RF on the IRD.
- Connect the ship's gyro cable from the ship's gyro to the Ship's Gyro connector on the ACU.
- Connect the power cable from the AC power connector on the rear of the ACU to a power source at 110- 220 V AC.
- Press the POWER ON switch on the rear of the ACU to power on the antenna.

### Gyrocompass Connection

For optimum satellite tracking, you must connect a Gyrocompass to the antenna system through the gyrocompass interface on the rear of the ACU. If the ship's gyrocompass output is other than NMEA 0183 and NMEA 2000 a separate purchase of an NMEA converter is required.

### Recommended Cable

- NMEA 0183 Gyrocompass Interface Cable (Customer supplied)
- Connector Type: 2 conductors for NMEA 0183, 5 conductors for NMEA 2000
- NMEA heading sentence: xx HDT (4800 Baud, 8, N,1) If there is no HDT sentence then use HDM sentence instead.
- NMEA 2000 heading PGN Number = 127250 (Vessel Heading)

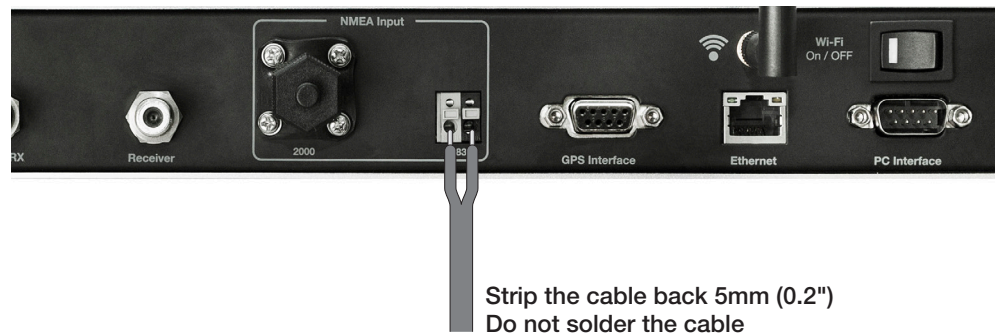

Figure 06. Gyrocompass Connection

### Connecting the System without a Ship's Gyrocompass

For a vessel where the ship's gyrocompass is not installed or is difficult to be connected, the Intellian Gyro-Free satellite search function will be automatically enabled to allow the antenna to lock onto the desired satellite without requiring an external heading input.

The table below provides an example of the Gyro-Free satellite search algorithm. The Search 1 or Search 3 satellite search pattern will be triggered according to the existence of heading input and the setting of the heading device.

**Search 1:** This mode is entered from Search 1 or Search 3. The antenna will search for the target satellite by turning its azimuth angle in CW(Clockwise) and CCW(Counter Clockwise) direction in a turn rotation until the antenna receives the lock signal from the receiver or the DVB(Digital Video Broadcasting) transponder of the target satellite is decoded by the antenna.

**Search 3:** The antenna will search for the target satellite by turning its azimuth angle directly to the position calculated using the ship's heading input and lock onto the satellite.

Setting of Heading Device			
Existence of Heading Data	No Device	NMEA / NMEA 2000	Ground Test
With Heading Data	Search 1	Search 3	Search 3
Without Heading Data	Search 1	Search 1	Search 3

### Quick Setup Procedure

- Set the satellite with DVB transponder as the target satellite.
- Set "None" to the heading device.
- The antenna will search for the target satellite by turning its azimuth angle in CCW direction and lock onto the satellite signal until the antenna receives a lock signal from the receiver or the DVB transponder of the target satellite is decoded.
- Set the heading device as NMEA.
- Enter "Manual search" menu and touch "Function" key to save the current settings. Intellian ACU will automatically calculate and save the bow offset.
- Upload the real TARGET satellite pre-configured from the library.



## PC to ACU Communication Setup

You can establish data communication between a PC and the ACU using one of the following methods.

### TCP/IP Connection

#### Connection through Front Panel Management Port

This method is most recommended. The network is automatically configured by DHCP without the need of additional PC IP configuration.

#### Management Ethernet Port

1. Connect an Ethernet cable from a PC Ethernet port to the Management port on the front of the ACU.
2. Network connection is established.
3. Use the following IP address to access Intellian Aptus® or Aptus Web page.
  - 192.168.2.1 (Default)



#### Connection through Rear Panel Ethernet Port

This method requires separate IP configuration on a PC.

#### Ethernet Port

1. Connect an Ethernet cable from a PC Ethernet port to an available LAN port of a Switch/Hub.
2. Go to Control Panel > Network and Sharing Center > Change Adapter Settings and right-click on the Local Area Connection then click Properties
3. Select TCP/IPv4, then click Properties.
4. Change the network settings on a PC;
  - IP: 192.168. 0.222 (Secondary: 10.10.1.2)
  - Subnet Mask: 255.255.255.0
  - Gateway: 192.168.0.223 (Secondary: 10.10.1.1)
5. Use the following IP address to access Intellian Aptus® or Aptus Web page.
  - Default: 192.168.0.223 (Secondary: 10.10.1.1)

### **Serial/USB Connection**

#### **Serial Connection      Connection through Serial Port**

1. Connect a 9-pin Serial cable from the PC INTERFACE connector on the ACU to the 9-pin serial port on your PC.
2. If there is not a 9-pin serial port on the PC, use a USB-Serial adapter.

#### **USB Connection      Connection through USB Port**

There are two USB(USB-to-Serial) ports available on the ACU. One is on the front and the other is on the rear.

1. Connect a USB cable from a USB port on your PC to the USB port on the ACU.

**Note:** The t80W/t80Q also supports Wi-Fi connection between a PC and the ACU.

## Wi-Fi Connection

### Setup Wi-Fi Connection

- Setting up the ACU in order to access Wi-Fi
- Setting up the PC (AP Mode) in order to access Wi-Fi
- Remote Aptus Web Confirmation

### Setting up the ACU in order to access Wi-Fi



#### 1. Turning on the Wi-Fi switch

Turn on the switch on the back of the ACU, and 30 seconds after enabling the power supply, confirm if a red light appears on the switch.

### Setting up the PC in order to access Wi-Fi

1. Setting up my computer’s wireless IP address

- Control Panel> Network and Sharing Center > Change Adapter Settings > Right click on the “Bluetooth Wireless Connection”> Click Properties

After selecting TCP/IPv4, click on the properties menu, then select "Obtain an IP address automatically."

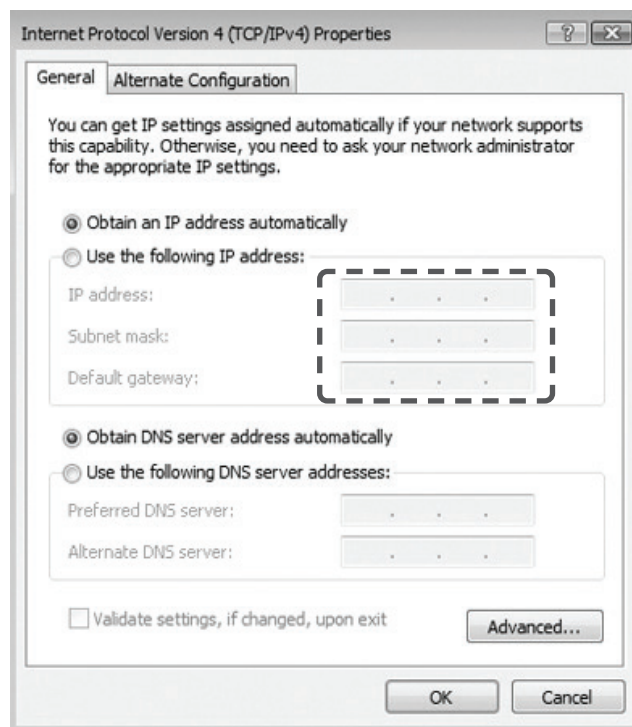

2. To manually change the network settings, click on "Use the following IP address" and use the settings listed below.

#### Case #1

If iARM Module’s IP is known

The iARM module’s default IP is 192.168.1.223

PC IP : 192.168.1.222

Subnet Mask : 255.255.255.0

GateWay : 192.168.1.223

#### Case #2

iARM Module’s IP is unknown

The iARM module’s secondary IP is 10.10.10.1

**PC IP : 10.10.10.2**

**Subnet Mask : 255.255.255.0**

**GateWay : 10.10.10.1**

3. Connect Wi-Fi in AP mode.

After clicking on the Windows Wireless Connection icon, click on intellian-TVRO (Default).

4. Enter the Network Security Key.

Key: intellian1234 (Default)



5. You can confirm the logo and version data by accessing <http://192.168.1.223>

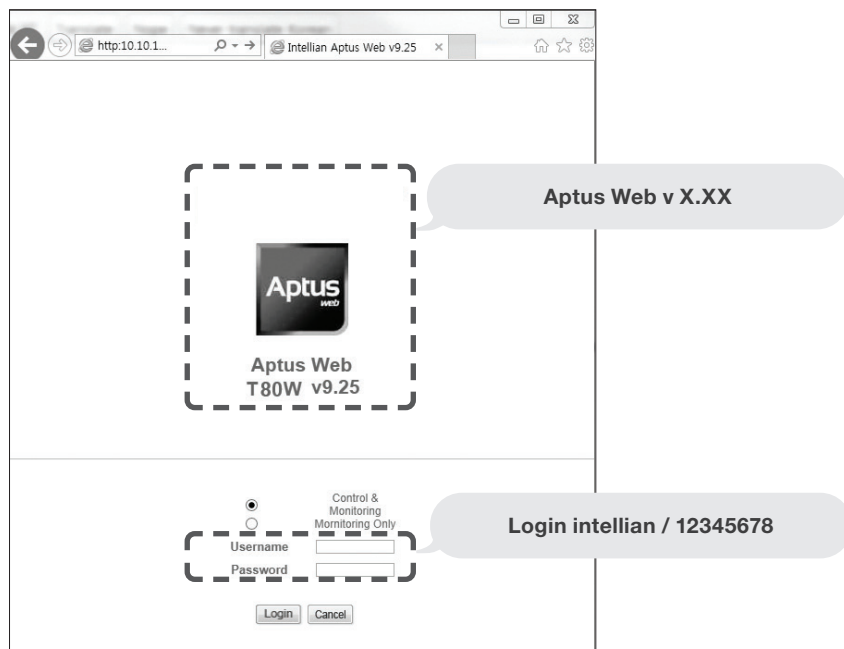

Login by entering the ID / Password listed below.

**Username:** intellian (Default)

**Password:** 12345678 (Default)

6. When you login, make sure that all the data within every page is being displayed correctly.



# OPERATING THE ACU

## Introduction

## Normal Mode

Startup

Change of Target Satellite

Monitoring Current Status

## Setup Mode

Setting the Region

## Installation Settings

Installation

## Antenna Settings

Setting Antenna Manual Search

Setting POL. Angle

Setting Antenna Search Parameter

Setting Antenna Parameters

Executing Antenna Diagnosis

## Satellite Settings

Setting the Satellite Pair

Edit Satellite Information

Finding Transponders

## System Settings

Setting Location

System Management

Key Lock

## Introduction

This section of the handbook describes how to set up your Satellite TV System after installation using the ACU.

### ACU Soft Keys

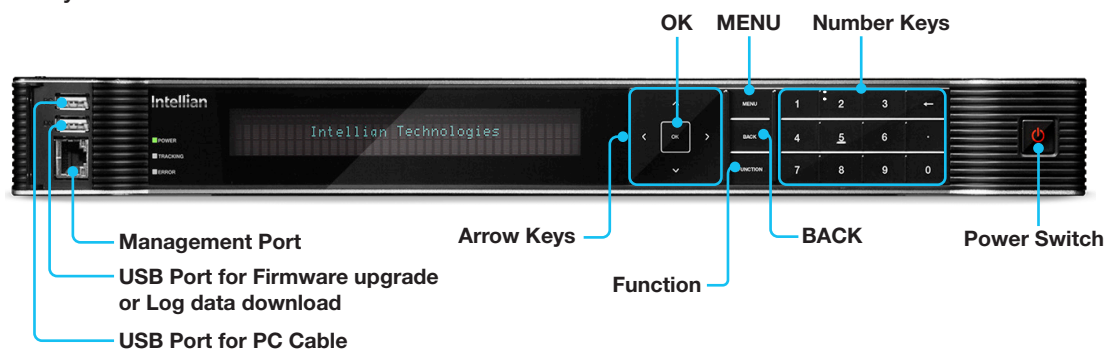

### Soft Key Functions

Soft key	Function
<b>MENU</b>	Enter SETUP mode
<b>BACK</b>	In SETUP mode: returns to the previous menu / option or save the adjusted settings. In normal mode: returns to the first page of the antenna's current status.
<b>FUNCTION</b>	Save the adjusted settings.
<b>ARROW KEYS</b>	Select from the alternative options to increase or decrease the selected character to the desired value.
<b>OK</b>	Enter the next step / menu
<b>NUMBER KEYS</b>	Input the numbers



**WARNING:** Please ensure that your Intellian system is ALWAYS powered ON upon leaving the dock. Failure to follow these instructions could result in damaging mechanical parts in the antenna and/or possibly void your warranty. Intellian strongly recommends to restrain the antenna pedestal properly while underway when power is removed from the antenna. The normal operating condition is to remain powered up at all times.



## Normal Mode

### Startup

With the system installed and power applied, the ACU screen will show the following sequence.

```
INTELLIAN TECHNOLOGIES INC.
INTELLIAN t80W
```

1. The data communication is being established between the antenna and the ACU.

```
INITIALIZE - ANTENNA INFO
INTELLIAN t80W
```

2. The ACU receives antenna information.

```
INITIALIZE - EL POSITION
INTELLIAN t80W
```

3. The elevation angle and cross level angle are initialized.

```
INITIALIZE - AZIMUTH POSITION
INTELLIAN t80W
```

4. The azimuth angle is initialized.

```
INITIALIZE - FIND NOISE LEVEL
INTELLIAN t80W
```

5. The antenna measures the noise levels of the default satellites.

```
INITIALIZE - SAT POSITION
INTELLIAN t80W
```

6. The antenna returns to the target satellite position.

```
‡ SEARCH 19.2E      ASTRA_1  AGC: 301 • VL ‡
  AZ: 160.9(340.9) EL: 29.0  SK: -21.1 Fn
```

7. The antenna is searching for the target satellite.

```
‡ TRACKING          ASTRA_1  AGC: 301 • VL ‡
  AZ: 160.9(340.9) EL: 29.0  SK: -21.1 Fn
```

8. The antenna has locked onto the target satellite and is now tracking.

### Change of Target Satellite

Your antenna is programmed with three selected target satellites as default. To change the target satellite, press the LEFT soft key. The target satellite is changed and is automatically tracked by the antenna.

```

# TRACKING [→] ASTRA_1      #
                    [2] HOT_SPOT      Fn
    
```

1. Press ② key for tracking satellite [2].

```

# TRACKING [→] HOT_SPOT     #
                    [1] ASTRA_1     Fn
    
```

2. The antenna is tracking satellite [2].

```

# TRACKING [→] ASTRA_1      #
                    [2] HOT_SPOT [3] ASTRA_3  Fn
    
```

3. Press ③ key for tracking satellite [3] (when in Tri-sat mode).

```

# TRACKING [→] ASTRA_3      #
                    [1] ASTRA_1 [2] HOT_SPOT  Fn
    
```

4. The antenna is tracking satellite [3].

**NOTE:** If you have any problems while setting target satellites, contact the Intellian service team for support.

### Monitoring Current Status

While POWER ON the Intellian ACU displays the status of the antenna.

Various ACU displays may be shown according to the current status of the antenna.

```

# SEARCH  [→] ASTRA_1  #
                [2] HOT_SPOT  [3] ASTRA_3

```

1. The antenna is searching for satellite [ 1 ].

```

# TRACKING [→] ASTRA_1  #
                [2] HOT_SPOT  [3] ASTRA_3  Fn

```

2. The antenna is tracking satellite [ 1 ].

```

ANTENNA IS UNWRAPPING

```

3. The antenna is winding /unwinding the cables in the antenna. The necessity of “unwrap” is based on how far the ship has turned in one direction or the other.

```

# TRACKING [→] ASTRA_1  #
                [2] HOT_SPOT  [3] ASTRA_3  Fn

```

4. The antenna is again tracking satellite [ 1 ].

```

SAVE CURRENT SAT INFO?
→YES                      NO

```

5. Press the FUNCTION key to save current satellite information or abort and return to the main display.

```

# TRACKING [→] ASTRA_1  #
                [2] HOT_SPOT  [3] ASTRA_3  Fn

```

6. While the antenna is tracking satellite [ 1 ], press the RIGHT arrow key to display current antenna information.

```

# TRACKING 19.2E ASTRA_1 AGC: 301• VL #
  AZ: 160.9( 340.9) EL: 29.0 SK: -21.1  Fn

```

7. True azimuth [ 160.9] position of the antenna is the sum of ships heading 180.0 [ HDG ] and antenna relative [ 340.9 ]. Current IF signal level (AGC) is displayed .

• will be only displayed when signal is strong enough to lock. VL indicates vertical low band. VH: vertical High, HL: horizontal low, HH: horizontal high. Press the UP and DOWN arrow keys to increase and decrease the LNB skew angle .

If the Up and Down arrow keys are unseen, press the OK key three times.

```

# DVB_D F: 11509 S: 22000 X0001 AGC: 301 #
      4.53E 52.22N HDG: 000.0 L: 9750 Fn
    
```

8. Press the RIGHT arrow key to display current satellite, GPS and ship's heading [ HDG ] information.

**Satellite Information :**  
 Frequency : 11509 MHz  
 Symbol rate : 22000 kSps  
 Verification method : DVB\_ Decode  
 LNB local frequency : 9750 MHz

**GPS Information :**  
 Longitude : West /East  
 Latitude : North/South

```

# [PWR] ANT: 23.9V      LNB: 13V + 0KHz #
      ACU: 27.0V      IRD: 13V + 0KHz
    
```

9. Press the RIGHT arrow key to display ACU and antenna ,LNB and IRD voltage information.

**Antenna and ACU Voltage :**  
 Due to the voltage losses across the multi-conductor cables, ensure that the minimum ACU operation voltage is within 27 ±1 V and minimum antenna operation voltage is above 16V.

**LNB and IRD Voltage :**  
 13 V + 0KHz (Vertical Low)  
 18V + 0KHz (Horizontal Low)  
 13V + DiSEqC 22 KHz tone (Vertical High)  
 18V + DiSEqC 22 KHz tone (Horizontal High)

```

# W3-1117Q   ANT. Serial   4.00/4.00 #
      BP-TA01   ACU Serial   4.00(2.00)
    
```

10. Press the RIGHT arrow key to display Antenna, ACU and Library version.  
 Keep pressing the RIGHT arrow key to return to the main display.

## Setup Mode

To enter Setup Mode simply follow the instructions below:

```
← TRACKING 19.2E ASTR_1 AGC: 301● VL →  
AZ: 160.9( 340.9) EL: 29.0 SK: ←-21.1→ Fn
```

1. While the antenna is tracking , press the MENU key for setup mode.

```
                SETUP MODE ?  
→ YES                NO
```

2. Press the LEFT key to move cursor to YES and press the OK key to enter setup mode or press the RIGHT key to move cursor to NO and press the OK key to abort and return to the main display.

### Setting the Region

```

                SETUP MODE ?
          → YES                               NO
    
```

1. Press the LEFT arrow key to move cursor to YES and press the OK key to enter SETUP mode.

```

+ANTENNA           → +SATELLITE
+SYSTEM            +INSTALLATION
    
```

2. Press the LEFT arrow key to move cursor to SATELLITE and press the OK key to enter SATELLITE menu.

```

+SET SAT. PAIR     +EDIT SATELLITE
→ +SET REGION      +FIND TRANSPONDER
    
```

3. Press the DOWN arrow key and the OK key to enter SET REGION menu.

```

→ SELECT CONTINENT  SELECT REGION
                   EUROPE        NETHERLANDS
    
```

4. Press the arrow keys to select parameter you wish to edit and press the OK key to edit parameter. Press the BACK key to save or abort and return to the main display.

```

SELECT CONTINENT   SELECT REGION
  ▲ EUROPE ▼      NETHERLANDS
    
```

5. Set the CONTINENT.  
Press the UP and DOWN arrow keys to select the continent that you are in.  
Press the OK key to set the CONTINENT.

```

SELECT CONTINENT   SELECT REGION
  ▲ EUROPE ▼      ▲ NETHERLANDS ▼
    
```

6. Press the BACK key to load the current setting or abort and return to the previous view.

```

                                LOAD ?
          → YES                                NO
    
```

7. Press the BACK key to load the current setting or abort and return to the main display.

```

LOADING ... #####0000000000000000
DO NOT TURN OFF !
    
```

8. Setting is being loaded to the system.  
 The ACU will restart the system automatically after uploading the setting.  
 DO NOT turn off ACU power while uploading is being processed.

```

# SEARCH [→] ASTRA_1 #
          [2] HOT_SPOT   [3] ASTRA_3
    
```

9. Region information has been updated.

**NOTE:** If you have any problems while performing these steps, contact the Intellian service team for support. And refer to the "Appendix: Library Upgrade Guide" page for more details.

## Installation Settings

### Installation

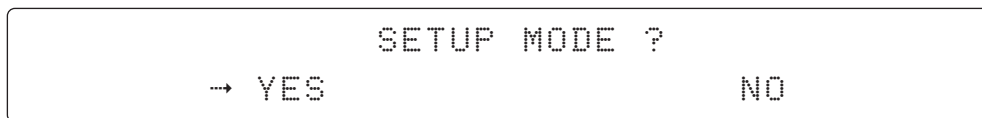

1. Press the LEFT arrow key to move cursor to YES and press the OK key to enter setup mode.

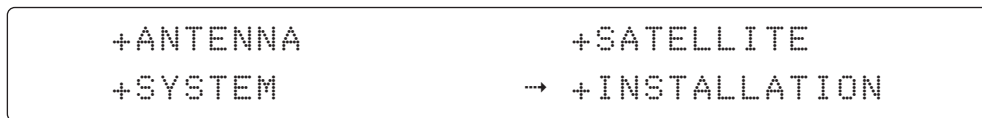

2. Press the arrow keys to move cursor to INSTALLATION and press the OK key to enter INSTALLATION menu.

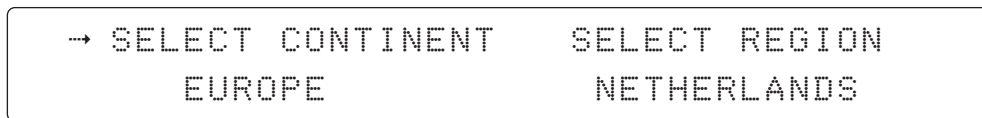

3. Press the arrow keys to select parameter you wish to edit and press the OK key to edit the selected parameter. Or press the BACK key to save or abort and return to the main display.

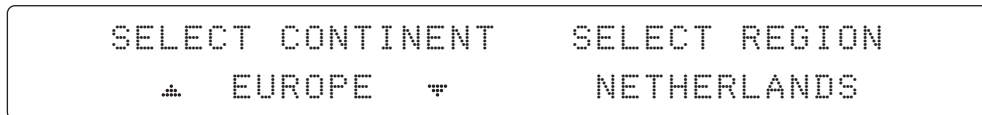

4. Set the CONTINENT.  
Press the UP and DOWN arrow keys to select the continent that you are in.  
Press the OK key to set the CONTINENT.

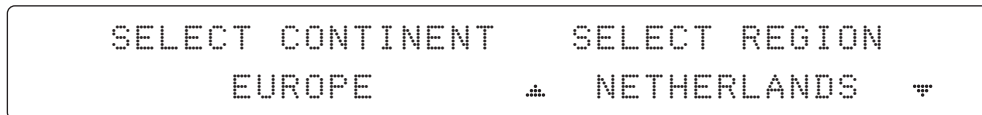

5. Set the REGION.  
Press the UP and DOWN arrow keys to select the region that you are in.  
Press the OK key to set the REGION.



LATITUDE	LONGITUDE
▲ 52.22N ▼	4.53E

6. Set the current LATITUDE .

Press the LEFT and RIGHT arrow keys until the desired character is underscored (selected). Press the UP and DOWN arrow keys to increase or decrease the value. Or press the NUMBER keys to set the desired value directly. Press the OK key to set the LATITUDE.

LATITUDE	LONGITUDE
52.33N	▲ 4.53E ▼

7. Set the current LONGITUDE.

Press the LEFT and RIGHT arrow keys until the desired character is underscored (selected). Press the UP and DOWN arrow keys to increase or decrease the value. Or press the NUMBER keys to set the desired value directly. Press the OK key to set the LONGITUDE.

GYRO TYPE	BOW OFFSET
▲ NMEA ▼	000

8. Set the GYRO TYPE.

Determine the type of gyro compass that is used on the ship. Ensure that the Gyro Type is set correctly. Press the UP and DOWN arrow keys to select the gyro type and press the OK key to set the GYRO TYPE.

GYRO TYPE	BOW OFFSET
NMEA	▲ 000 ▼

9. Set the BOW OFFSET

The radome should be positioned with the BOW marker aligned as close as possible to the centerline of the ship. Small variations from actual alignment can be compensated with the BOW OFFSET, so precise alignment is not required.

Press the LEFT and RIGHT arrow keys until the desired character is underscored (selected). Press the UP and DOWN arrow keys to increase or decrease the value. Or press the NUMBER keys to set the desired value directly. Press the OK key to set the BOW OFFSET.

	LOAD ?	
→ YES		NO

10. Press the BACK key to load the current setting or abort and return to the main display.

```
LOADING ... #####  
DO NOT TURN OFF !
```

10. Setting is being loaded to the system.  
The ACU will restart the system automatically after uploading the setting.  
DO NOT turn off ACU power while uploading is being processed.

```
4 SEARCH [→] ASTRA_1  
          [2] HOT_SPOT      [3]ASTRA_3
```

11. Region information has been updated.

## Antenna Settings

### Setting Antenna Manual Search

```

                SETUP MODE ?
          → YES                               NO
  
```

1. Press the LEFT arrow key to move cursor to YES and press the OK key to enter SETUP mode.

```

          → +ANTENNA                          +SATELLITE
            +SYSTEM                            +INSTALLATION
  
```

2. Press the OK key to enter ANTENNA menu.

```

  ← → +MANUAL SEARCH                          +SET POL ANGLE  →
            +SEARCH PARAM                      +SET PARAMETERS
  
```

3. Press the OK key to enter MANUAL SEARCH menu.

```

STEP SIZE  AZIMUTH  ELEVATION  AGC
#  0.2  #  ← 288.7  →  ↑ 41.0  ↓  288  Fn
  
```

4. Current IF signal level (AGC) is displayed to assist you in manually peaking EL for best signal level. Press the NUMBER key to change the step size(Range : 0.1~9.9). Press the LEFT and RIGHT arrow keys to move azimuth by step size (Range : 0~360). Press the UP and DOWN arrow keys to move elevation by step size(Range : 0~90). Press the FUNCTION key to save the bow offset when the antenna locks onto the peak level of the AGC signal.

```

                SAVE CURRENT SAT INFO?
          → YES                               NO
  
```

5. If the current settings are able to lock onto the satellite, press the LEFT key to move cursor to YES and press the OK key to save the bow offset. It will shorten the satellite acquisition time next time. Or you can press the RIGHT key to move cursor to NO and press the OK key to abort and return to the previous view.

### Setting POL. Angle

```

                SETUP MODE ?
          → YES                               NO
    
```

1. Press the LEFT key to move cursor to YES and press the OK key to enter setup mode.

```

          → +ANTENNA                          +SATELLITE
            +SYSTEM                            +INSTALLATION
    
```

2. Press the OK key to enter ANTENNA menu.

```

  ⌄   +MANUAL SEARCH → +SET POL ANGLE   ⌄
            +GO POSITION       +SEARCH PARAMETERS
    
```

3. Press the RIGHT arrow key to move cursor to SET POL ANGLE and press OK key to enter SET POL ANGLE menu.

```

                SELECT LNB POL. ANGLE MENU
          ⌄                CALIBRATION                ⌄
    
```

4. Press the UP and DOWN arrow keys to select the menu and press the OK key to run the selected operation ' CALIBRATION ' or ' MANUAL ADJUST '. When you replace the control board, select CALIBRATION to calibrate LNB skew angle.

```

  LNB POL ANGLE   POLARITY   SIGNAL : 180
    ⌄   20.0   ⌄   ⌄ LINEAR ⌄
    
```

5. Press the UP and DOWN arrow keys to increase or decrease the LNB skew angle manually. Press BACK key to return to the main display. Press the LEFT and RIGHT arrow keys to select the polarization between Linear and Circular. Press BACK key to return to the main display.

### Setting Antenna Search Parameter

```

                SETUP MODE ?
            → YES                               NO
    
```

1. Press LEFT arrow key to move cursor to YES and press OK key to enter SETUP mode.

```

    → +ANTENNA                               +SATELLITE
      +SYSTEM                                 +INSTALLATION
    
```

2. Press OK key to enter ANTENNA menu.

```

    ⚡ +MANUAL SEARCH                          +SET POL ANGLE ⚡
      +SEARCH PARAM                          → +SET PARAMETER
    
```

3. Press DOWN arrow keys to move cursor to SEARCH PARAM and press OK key to it.

```

    SEARCH WAIT TIME      INCREMENT STEP
    ⚡      030           ▾      0.50
    
```

4. Set SEARCH WAIT TIME and INCREMENT STEP

Set the time-out for automatic initiation of a search after the signal level drops below the predefined threshold value (Range : 1 - 120 sec) and set increment step size (Range : 0.01 - 5.00 sec).

```

    SEARCH1 AZ      SEARCH1 EL
    ⚡      400           ▾      06
    
```

```

    SEARCH3 AZ      SEARCH3 EL
    ⚡      003           ▾      04
    
```

5. Set SEARCH 1 and 3 AZ(Azimuth) range and EL (Elevation) range.  
SEARCH 2 is reserved for future use.

A search pattern 1 or 3 will be initiated according to which GYRO TYPE is selected and the existence of the gyro input.

**Search 1:** a search pattern 1 will automatically be initiated when the ship's heading input does not exist / is failed. The antenna will go to the relative azimuth position 0° at the calculated elevation and search in the azimuth CW and CCW direction in a turn rotation and search up + 0.5° & down -0.5° with a total 6 (±3°) in elevation. The search cycle will repeat until the antenna receives the lock signal from the receiver or the DVB transponder of the target satellite is decoded by the antenna. If the desired signal is found and above the predefined detect level, the ACU will enter to Search 3. However, the antenna will not initiate Search 3 pattern but go into TRACKING mode immediately if the desired signal is above the predefined tracking threshold level. If the detected signal is below the predefined tracking threshold level, the search 1 will repeat and start 3° away from the current position.

**Search 1 Antenna Motion**

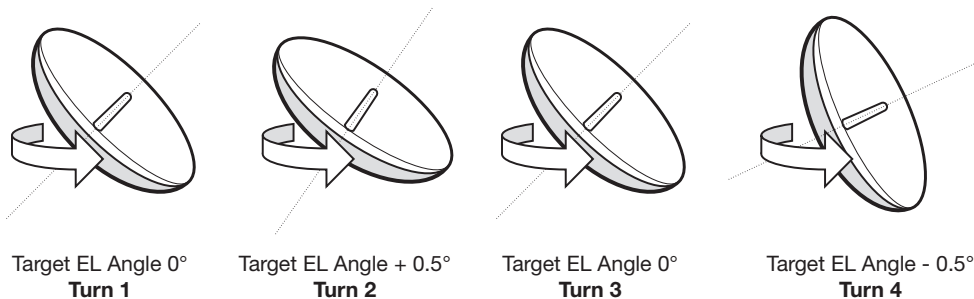

**Search 3:** a search pattern 3 will automatically be initiated when AGC falls below the current tracking level threshold value. If the desired signal is found and above the predefined tracking level, the ACU will terminate Search 3 and go into TRACKING mode.

A search pattern will automatically be initiated when AGC falls below the current threshold setting (indicates that satellite signal has been lost). Search is conducted in a two-axis pattern consisting of alternate movements in azimuth (AZ) and elevation (EL) as forming expanding square indicated as below diagram.

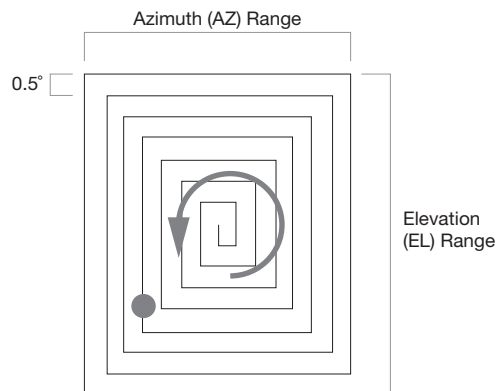

### Setting Antenna Parameters

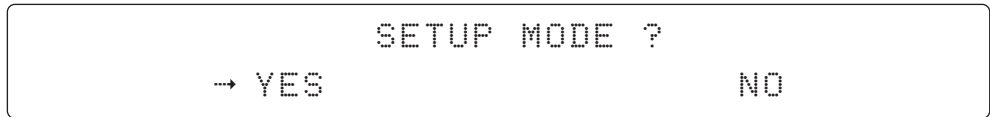

1. Press the LEFT key to move cursor to YES and press the OK key to enter setup mode.



2. Press the OK key to enter ANTENNA menu.

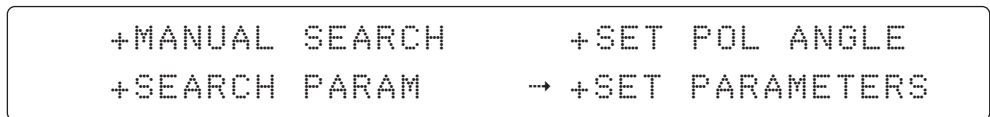

3. Press the RIGHT arrow key to move cursor to SET PRAMETERS menu and press the OK key to enter SET PARAMETERS menu.

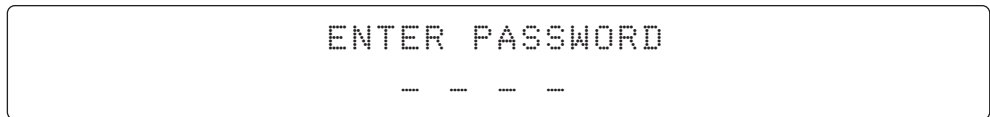

4. Access to the password protected system. Setup parameters is only required after installation or repairs of your antenna system. These parameters should only be changed by an authorized service technician. Improper setting of these parameters will cause your system to perform improperly.  
Press 4-digit password to enter SET PRAMETERS menu. (1590).

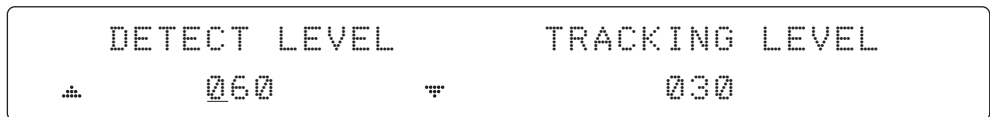

5. Set the DETECT LEVEL. (Range : 1-200)  
The detect level is to set the satellite signal detection level.

Press the LEFT and RIGHT arrow keys until the desired character is underscored (selected). Press the UP and DOWN arrow keys to increase and decrease the selected character. Or press the NUMBER keys to set the desired value directly.

Press the OK key to set the new DETECT LEVEL.



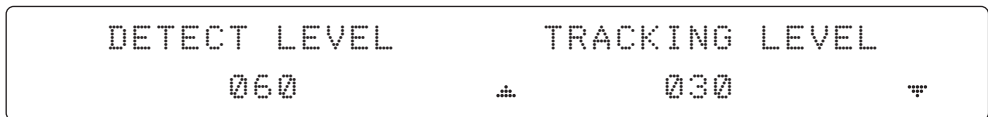
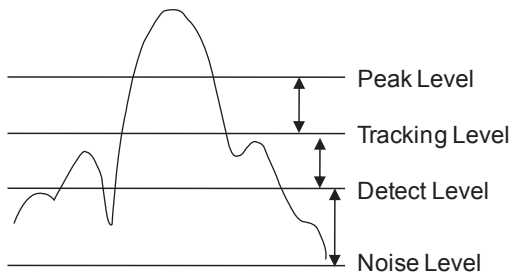

6. Set the TRACKING LEVEL. (Range : 1-200)  
 The tracking level is to set the satellite signal tracking level.

Press the LEFT and RIGHT arrow keys until the desired character is underscored (selected). Press the UP and DOWN arrow keys to increase and decrease the selected character. Or press the NUMBER keys to set the desired value directly.

Press the OK key to set the new TRACKING LEVEL.



7. Set the BOW OFFSET. (Range :0 – 360°)  
 The bow offset is to offset the angle difference between the antenna’s bow and the ship’s bow.

Press the LEFT and RIGHT arrow keys until the desired character is underscored (selected). Press the UP and DOWN arrow keys to increase and decrease the selected character. Or press the NUMBER keys to set the desired value directly.

Press the OK key to set the new BOW OFFSET.



8. Set the EL ADJUST. (Range : ± 5°)  
 The elevation adjust is to offset the angle difference between the mechanical elevation angle and actual elevation angle.

Press the LEFT and RIGHT arrow keys until the desired character is underscored (selected). Press the UP and DOWN arrow keys to increase and decrease the selected character. Or press the NUMBER keys to set the desired value directly.

Press the OK key to set the new EL ADJUST.



9. Set the VOLT THRES.

The voltage threshold is to distinguish the voltage between 13 V and 18V.

Press the LEFT and RIGHT arrow keys until the desired character is underscored (selected). Press the UP and DOWN arrow keys to increase and decrease the selected character. Or press the NUMBER keys to set the desired value directly.

Press the OK key to set the new VOLT THRES.

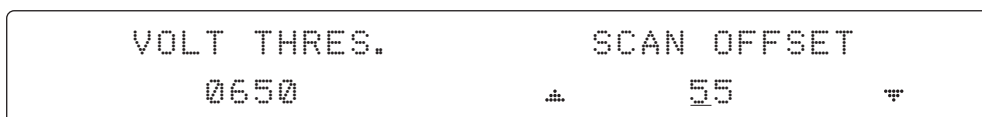

10. Set the SCAN OFFSET. (Range : 0 - 90)

The scan offset is to offset the angle difference between the black marker on the sub-reflector and the optical sensor.

Press the LEFT and RIGHT arrow keys until the desired character is underscored (selected). Press the UP and DOWN arrow keys to increase and decrease the selected character. Or press the NUMBER keys to set the desired value directly.

Press the OK key to set the new SCAN OFFSET.

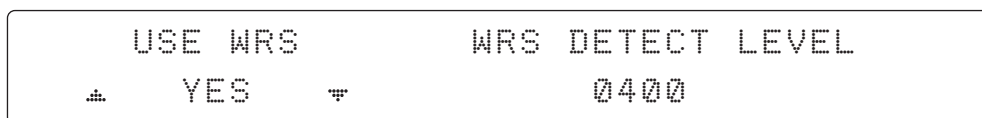

11. Set the USE WRS.

USE WRS is to determine whether the system uses WRS LEVEL or not.

USE WRS and WRS LEVEL are pair functions.

Press the UP and DOWN arrow keys to select "YES" to USE WRS or "NO" to NOT USE WRS and press the OK key to set the USE WRS.

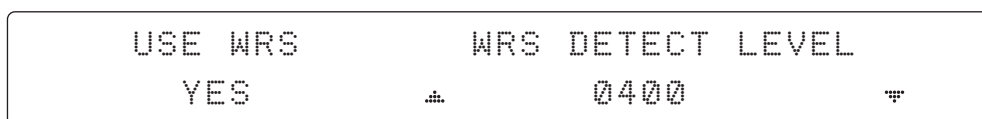

12. Set the WRS DETECT LEVEL. (Range : 10 – 5,000)

The WRS level is to set the WRS detection level.

Press the LEFT and RIGHT arrow keys until the desired character is underscored (selected). Press the UP and DOWN arrow keys to increase and decrease the selected character. Or press the NUMBER keys to set the desired value directly.

Press the OK key to set the new WRS DETECT LEVEL.

```

      USE OFFSET          OFFSET DIFF.
      ^      YES          v      -040
    
```

13. Set the USE OFFSET.

USE OFFSET is to determine whether the system uses OFFSET DIFF or not.  
 USE OFFSET and OFFSET DIFF are pair functions.

Press the UP and DOWN arrow keys to select "YES" to USE OFFSET or "NO" to NOT USE OFFSET and press the OK key to set the USE OFFSET.

```

      USE OFFSET          OFFSET DIFF.
      YES                ^      -040          v
    
```

14. Set the OFFSET DIFF. (Range : ±100 )

The offset difference is to offset the signal difference between RHCP and LHCP.

Press the LEFT and RIGHT arrow keys until the desired character is underscored (selected).  
 Press the UP and DOWN arrow keys to increase and decrease the selected character. Or  
 press the NUMBER keys to set the desired value directly.

Press the OK key to set the new OFFSET DIFF.

```

      VERIFY TIME        OPERATION
      ^      1500        v      SAVE
    
```

15. Set the VERIFY TIME. (Range : 10 ~ 5000 )

The VERIFY TIME is to set the time of decoding to verify whether the signal detected is the  
 signal of the target satellite.

Press the LEFT and RIGHT arrow keys until the desired character is underscored (selected).  
 Press the UP and DOWN arrow keys to increase and decrease the selected character.  
 Or press the NUMBER keys to set the desired value directly.

Press the OK key to set the new VERIFY TIME.

```

      VERIFY TIME        OPERATION
      ^      1500        v      SAVE
    
```

16. Set OPERATION

Press UP and DOWN arrow keys to select OPERATION items.

**OPERATION\***

SAVE : Save and execute the current settings.

REBOOT : The antenna will restart automatically if REBOOT ANTENNA is ON.

**Executing Antenna Diagnosis**

```

                SETUP MODE ?
          → YES                                NO
    
```

1. Press the LEFT key to move cursor to YES and press the OK key to enter setup mode.

```

          → +ANTENNA                          +SATELLITE
            +SYSTEM                            +INSTALLATION
    
```

2. Press the OK key to enter ANTENNA menu.

```

    ← → +DIAGNOSTIC →
    
```

3. Press the arrow keys to move cursor to DIAGNOSTIC and press the OK key to enter DIAGNOSTIC menu.

```

          DIAGNOSTIC                          FULL TEST
          ↑ FULL TEST ↓                          READY
    
```

4. Press the UP and DOWN arrow keys to select a full diagnosis or single diagnosis and press the OK key to execute the selected diagnosis.

```

          DIAGNOSTIC                          FULL TEST
          FULL TEST                            #####-##5
    
```

5. A full diagnosis is completed.

```

          DIAGNOSTIC                          COMMUNICATION
          CODE 101                             RESULT : PASSED
    
```

6. The diagnosis result is shown.

**Diagnosis Code :**

CODE 101 : The data communication between the antenna and the ACU is tested.

CODE 102 : The azimuth motor is tested.

CODE 103 : The elevation motor is tested.

CODE 104 : The cross-level motor is tested.

CODE 105 : The azimuth encoder is tested.

CODE 106 : The cross-level encoder is tested.

CODE 107 : The gyro sensor is tested.

CODE 108 : The tilt sensor is tested.

CODE 109 : The sensor box motor is tested.

CODE 110 : The LNB is tested .

CODE 111 : The LNB skew motor is tested.

CODE 112 : The sub-reflector is tested.

CODE 113 : The antenna power is tested.

CODE 114 : The ACU power is tested.

CODE 115 : The receiver power is tested.

Test result: ●2●●-●●●●●●●●●●

● Test means passed. – Test means skipped. ? Test means under process.

Refer No. 2 to the diagnosis code 102 as shown above for occurred error explanation.

## Satellite Settings

### Setting the Satellite Pair

```

                SETUP MODE ?
          → YES                               NO
    
```

1. Press the LEFT arrow key to move cursor to YES and press the OK key to enter setup mode.

```

+ANTENNA                               → +SATELLITE
+SYSTEM                                +INSTALLATION
    
```

2. Press the RIGHT arrow key to move cursor to SATELLITE and press the OK key to enter SATELLITE menu.

```

→ +SET SAT. PAIR                       +EDIT SATELLITE
+SET REGION                             +FIND TRANSPONDER
    
```

3. Press the OK key to enter SET SAT. PAIR menu.

```

                SET TRIPLE SAT ?
          → YES                               NO
    
```

4. Move cursor to YES and press the OK key to enter Tri-Sat mode or move cursor to NO and press the OK key to enter Dual-Sat mode.

```

PRESET SLOT                            DEST. SATELLITE
▲ PRESET 1 ▼                            ASTRA_1
    
```

5. Press the UP and DOWN arrow keys to select PRESET SLOT 1, 2 and 3 in Tri-Sat mode or 1 and 2 in Dual-Sat mode.

```

RESET SLOT                             DEST. SATELLITE
PRESET 1                                ▲ ASTRA_1 ▼
    
```

6. Press the UP and DOWN arrow keys to select the DESTINED SATELLITE from the library (pre-programmed satellites). Press the OK key to set the DESTINED SATELLITE.

```

                SAVE ?
          → YES                               NO
    
```

7. Press the BACK key to save the current settings or abort and return to the main display.

**Edit Satellite Information**

```

                SETUP MODE ?
          → YES                               NO
    
```

1. Press the LEFT arrow key to move cursor to YES and press the OK key to enter setup mode.

```

+ANTENNA                → +SATELLITE
+SYSTEM                  +INSTALLATION
    
```

2. Press the RIGHT arrow key to move cursor to SATELLITE and press the OK key to enter SATELLITE menu.

```

+SET SAT. PAIR          → +EDIT SATELLITE
+SET REGION              +FIND TRANSPONDER
    
```

3. Press the RIGHT arrow key to move cursor to EDIT SATELLITE and press the OK key to enter EDIT SATELLITE menu.

```

                SELECT SATELLITE TO EDIT
          ▲      ASTRA_A  19.20E      ▼
    
```

4. Press the UP and DOWN arrow key to select the satellite that you wish to edit and press the OK key to edit the selected satellite.

```

+ LONGITUDE                EDIT NAME      +
          19.20E                ASTRA_1
    
```

5. Press the RIGHT and LEFT arrow keys to select parameter that you wish to edit. Press the OK key to edit parameter. Press the BACK key to save or abort and return to the main display.

```

+ LONGITUDE                EDIT NAME      +
          ▲ 19.20E ▼                ASTRA_1
    
```

6. Set the SATELLITE LONGITUDE . Press the LEFT and RIGHT arrow keys until the desired character is underscored(selected). Press the UP and DOWN arrow keys to increase or decrease the value. Or press the NUMBER keys to set the desired value directly. Press the OK key to set the SATELLITE LONGITUDE.

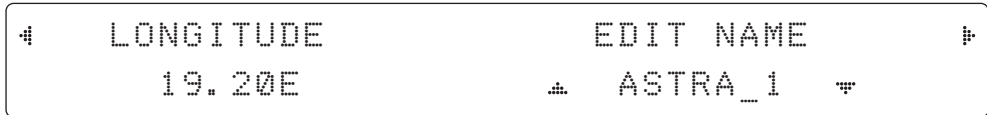

7. Set the SATELLITE NAME.  
Press the LEFT and RIGHT arrow keys until the desired character is underscored(selected).  
Press the UP and DOWN arrow keys to increase or decrease the value.  
Or press the NUMBER keys to set the desired value directly.  
Press the OK key to set the SATELLITE NAME.



8. Set the satellite VERIFICATION TYPE.  
Press the UP and DOWN arrow keys to select the Verification Method 1) while antenna is tracking the satellite signal and press the OK key to set the VERIFY TYPE.



9. Set the LNB VOLTAGE.  
Press the UP and DOWN arrow keys to select the LNB Voltage Supply Method 2) and press the OK key to set the VOLTAGE (“AUTO” is recommended ).



10. Set the DISEQC .  
Press the UP and DOWN arrow keys to select the DiSEqC Method 3) and press the OK key to set the DISEQC ( “AUTO” is recommended ).

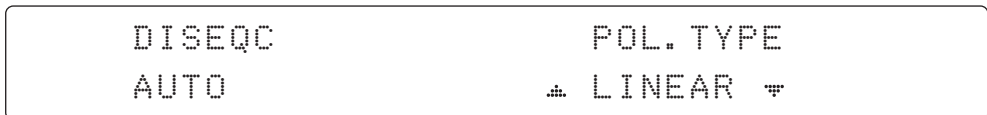

11. Set the POL TYPE manually.  
Press the UP and DOWN arrow keys to manually select LINEAR or CIRCULAR and press the OK key to set the POL TYPE.



```

LOCAL FREQ.
  ▲  10600  ▼
    
```

12. Set LOCAL FREQ.

Press the UP and DOWN arrow keys to select the LNB local frequency from the installed LNB. Or press the NUMBER keys to set the desired value directly. Press the OK key to set the parameter.

```

VL      FREQ          SYMBOL      NID
  ▲115094MHZ▼    22000kSpS    0X0001
    
```

13-1. Set the satellite FREQUENCY for VL( Vertical Low) band.

Press the LEFT and RIGHT arrow keys until the desired character is underscored (selected). Press the UP and DOWN arrow keys to increase or decrease the value. Or press the NUMBER keys to set the desired value directly. Press the OK key to set the FREQUENCY.

```

VL      FREQ          SYMBOL      NID
      115094MHZ    ▲22000kSpS▼    0X0001
    
```

13-2. Set the frequency SYMBOL rate (Maximum: 45,000).

Press the LEFT and RIGHT arrow keys until the desired character is underscored (selected). Press the UP and DOWN arrow keys to increase or decrease the value. Or press the NUMBER keys to set the desired value directly. Press the OK key to set the SYMBOL.

```

VL      FREQ          SYMBOL      NID
      115094MHZ    22000kSpS    ▲0X0001▼
    
```

13-3. Set the frequency NID (Network ID). Range is 0x0000 – 0xFFFF.

Press the LEFT and RIGHT arrow keys until the desired character is underscored (selected). Press the UP and DOWN arrow keys to increase or decrease the value. Or press the NUMBER keys to set the desired value directly. Press the OK key to set the NID.

Continue to press the OK key to set the satellite frequency, symbol rate and NID for HL(Horizontal/LHCP Low), VH (Vertical/RHCP High) and HH (Horizontal/LHCP High) in sequence.

**1) Verification Method**

AGC – use signal level for satellite tracking.  
DVB LOCK – use DVB Lock for satellite tracking.  
DVB DECODE – use DVB Decode for satellite tracking.  
DSS DECODE – use DSS Decode for satellite tracking.

**2) Voltage Supply Method**

AUTO- supply 13V or 18V to LNB.  
ONLY 13V – always supply 13V to LNB.  
ONLY 18V – always supply 18V to LNB.

**3) DISEQC Method**

AUTO – supply 0kHz or 22kHz to LNB.  
ONLY 0KHZ – always supply 0kHz to LNB.  
ONLY 22KHZ - always supply 22kHz to LNB.

### Finding Transponders

```

                SETUP MODE ?
          → YES                               NO
    
```

1. Press the LEFT arrow key to move cursor to YES and press the OK key to enter setup mode.

```

+ANTENNA           → +SATELLITE
+SYSTEM            +INSTALLATION
    
```

2. Press the RIGHT arrow key to move cursor to SATELLITE and press the OK key to enter SATELLITE menu.

```

+SET SAT. PAIR      +EDIT SATELLITE
+SET REGION         → +FIND TRANSPONDER
    
```

3. Press the DOWN arrow key and the OK key to enter FIND TRANSPONDER menu.

```

      BAND           FREQ.           SYMBOL
  ▲ VER LOW ▼      11509MHz         22000kSpS
    
```

4. Press the UP and DOWN arrow keys to select the frequency band you wish you edit. Press the OK key to edit the selected frequency.

```

      BAND           FREQ.           SYMBOL
      VER LOW ▲     11509MHz ▼     22000kSpS
    
```

5. Set the satellite FREQUENCY.

Press the LEFT and RIGHT arrow keys until the desired character is underscored (selected). Press the UP and DOWN arrow keys to increase or decrease the value. Or press the NUMBER keys to set the desired value directly. Press the OK key to set the FREQUENCY.

```

      BAND           FREQ.           SYMBOL
      VER LOW       11509MHz ▲ 22000kSpS ▼
    
```

6. Set the frequency SYMBOL RATE.

Press the LEFT and RIGHT arrow keys until the desired character is underscored (selected). Press the UP and DOWN arrow keys to increase or decrease the value. Or press the NUMBER keys to set the desired value directly. Press the OK key to set the SYMBOL.

```
[CHECK NID] F: 11509 S: 22000 0x0001  
PRESS OK      RECEIVED NID [0x0001]
```

7. CHECK NID is to verify the NID (Network ID) of the current tracking transponder. Press OK key to verify the NID [0x0001] only when “PRESS OK” function is activated. “PRESS OK” function will only be activated when DVB Lock signal is confirmed by the antenna. However, “NO LOCK” message will be displayed if DVB Lock signal can’t be confirmed.

# System Settings

## Setting Location

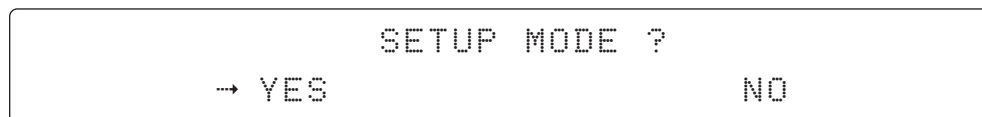

1. Press the LEFT arrow key to move cursor to YES and press the OK key to enter setup mode.

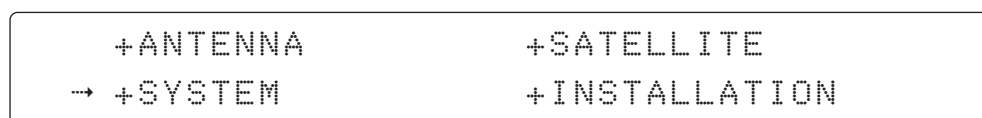

2. Press the DOWN arrow key to move cursor to SYSTEM and press the OK key to enter SYSTEM menu.



3. Press the RIGHT arrow key to move cursor to SET LOCATION and press the OK key to enter SET LOCATION menu.



4. Set the ship's GYRO TYPE\* and BAUD RATE  
 A search pattern 1 or 3 will be initiated according to which GYRO TYPE is selected and the existence of the gyro input. Set the BAUD RATE as 4800,9600,19200 or 38400 according to your device.

A search pattern 1 will be initiated automatically if the gyro input does not exist and the gyro type is selected other than GROUND TEST.

**Note:** The bow offset will not be saved automatically if Search 1 pattern is initiated. In this case, the antenna will need to retarget the desired satellite using Search 1 every time if the antenna restarts.

Setting of Heading Device			
Existence of Heading Data	No Device	NMEA / NMEA 2000	Ground Test
With Heading Data	Search 1	Search 3	Search 3
Without Heading Data	Search 1	Search 1	Search 3



**System Management**

```

                SETUP MODE ?
          → YES                               NO
    
```

1. Press the LEFT arrow key to move cursor to YES and press the OK key to enter setup mode.

```

      +ANTENNA                               +SATELLITE
    → +SYSTEM                               +INSTALLATION
    
```

2. Press the DOWN arrow key to move cursor to SYSTEM and press the OK key to enter SYSTEM menu.

```

    †   +SET LOCATION   → +MANAGEMENT   †
      +KEY LOCK
    
```

3. Press the ARROW key to move cursor to MANAGEMENT and press the OK key to enter MANAGEMENT menu.

```

                SELECT PROCESS TYPE
          †   BACKUP USER DATA   †
    
```

4. Press the UP and DOWN arrow keys to select the PROCESS TYPE 1) and press the OK key to set the PROCESS TYPE.

```

      BACK UP ANT INFO
      DO NOT TURN OFF ! #####
    
```

5. Processing message is displayed.

**SELECT PROCESS TYPE\***

**BACKUP USER DATA:** To backup the antenna settings set by user to the ACU.

**RESTORE USER DATA:** To restore the antenna by using the backup user data stored from the ACU.

**DEFAULT ACU-REMOTE P/W:** to default ID and Password of the Web Server.

**UPGRADE FROM USB:** to upgrade the system by using the firmware files from a specified folder in the USB flash drive.

**COPY LOG TO USB:** to copy the antenna log data from the system to the USB flash drive.

**BACKUP TO USB:** To backup the antenna settings to a specified folder in the USB flash drive.

**RESTORE FROM USB:** To restore the antenna by using the backup user data from a specified folder in the USB flash drive.

**UPGRADE ACU-REMOTE:** To upgrade the system using the Aptus Web firmware file from a specified folder in the USB flash drive.

**NOTE:** UPGRADE FROM USB, COPY LOG TO USB, BACKUP TO USB, RESTORE FROM USB and UPGRADE ACU-REMOTE options are displayed only if the USB flash drive is plugged into the USB port located in the front panel of the ACU.



**Key Lock**

```

                SETUP MODE ?
          → YES                                NO
    
```

1. Press the LEFT arrow key to move cursor to YES and press the OK key to enter setup mode.

```

      +ANTENNA                                +SATELLITE
    → +SYSTEM                                +INSTALLATION
    
```

2. Press DOWN arrow key to move cursor to SYSTEM and press OK key to enter it.

```

#   +SET LOCATION                                +MANAGEMENT   #
    → +KEY LOCK
    
```

3. Press arrow keys to move cursor to KEY LOCK and press OK key to enter it.

```

      KEY LOCK                                UNLOCK P/W
      ▲   ON   ▼                                1590
    
```

4. Press UP and DOWN arrow keys to choose whether or not to use key pad lock when entering the SETUP mode or saving the satellite information. Setup the password for entering the key pad lock. The factory default is 1590.

```

# TRACKING                                ASTRA_1   AGC: 301 • VL #
  *AZ: 160.9 (340.9) EL: 29.0   SK: -21.1 Fn
    
```

When KEY LOCK function is activated, the " \* " mark is displayed.



## **Introduction to Aptus®**

Requirements

## **Software Installation**

## **PC to ACU Communication Setup**

Starting Aptus®

Establishing a data communication

AutoUpdate

## **Toolbar Menus**

## **System Property Status Dashboard**

## **Work View Tabs**

1. Antenna – Basic Info.
2. Antenna – Advanced Info.
3. Satellite (Satellite View)
4. Graph View
5. Monitor
6. ACU System
7. Work View Functions

## Introduction to Aptus®

Intellian's Antenna PC Controller Software, Aptus® is a next-generation graphically based antenna remote control software. The Aptus® allows users to easily and conveniently set up the antenna by using a personal computer.

The minimum PC hardware and software requirements to install and run Aptus® are as below.

### Requirements

#### Hardware

Hardware	Requirements
CPU	Intel® Pentium® 4 or higher
Memory	512MB or higher
Video Card	DirectX9.0 or higher supported
	H/W acceleration supported
	Video Memory 128MB or higher
HDD	1GB or higher

#### Operating System and Software

Software	Requirements
Operating System	Windows XP SP or higher
Framework	Microsoft.Net Framework 3.5 Service Pack 1 or higher

## Software Installation

Double click the 'Aptus Setup.exe' icon  to install Aptus® directly onto your computer/ laptop. The InstallShield Wizard will guide you through the program setup process. The installation routine provides an icon on the desktop.

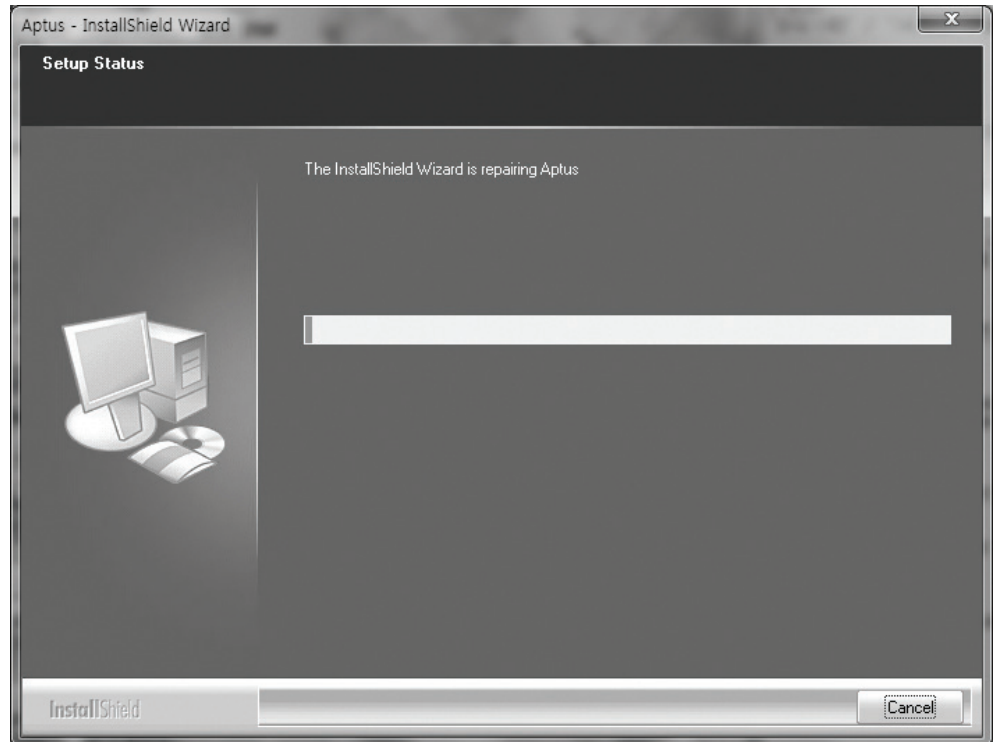

Click the icon to start the software. In addition, Intellian also provides patch files for software upgrade.

## PC to ACU Communication Setup

### Starting Aptus®

Double-click the Aptus® desktop icon, then Communication Window appears to establish the data communication between your PC and the ACU. Select options of connection method to access your ACU either through the Serial Port Communication or the Network Communication (TCP/IP).

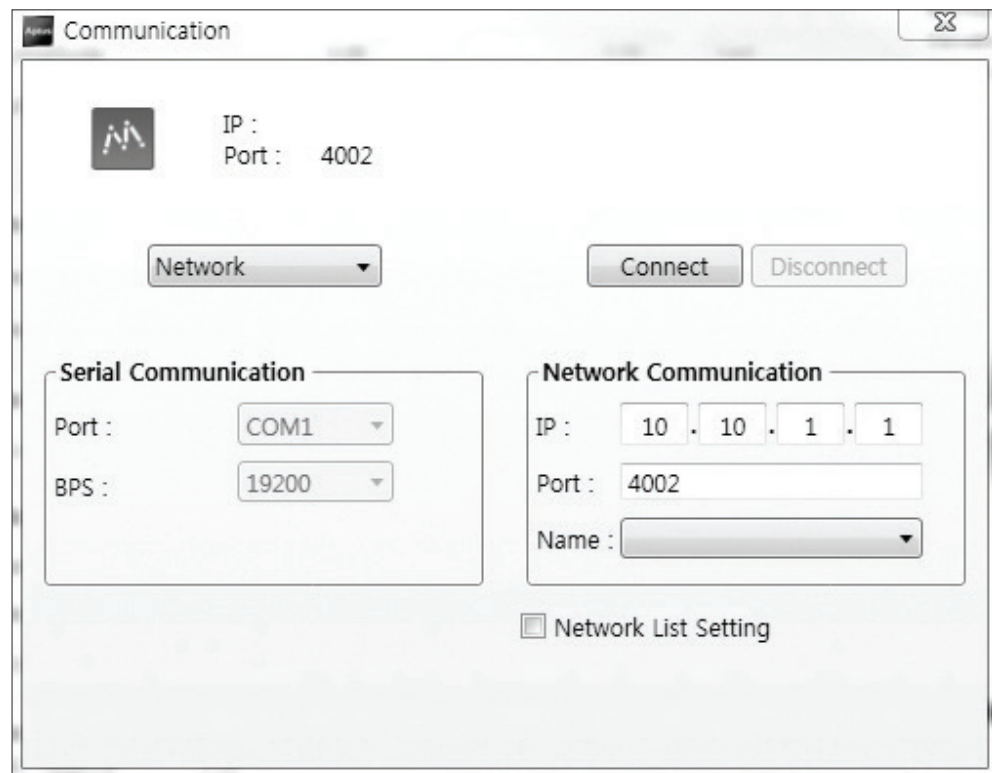

## Establish a data communication

### Access ACU through Serial Communication

1. Connect a 9 pin Serial cable between the PC INTERFACE connector on the ACU and the 9 pin Serial port on the PC. (Or you can use a USB cable to setup Serial connection between a PC and the USB port on the ACU.)
2. Select Serial at communication type combo-box.
3. The baud rate of the ACU is 57600.
4. Select a COM port which is not occupied by other devices.
5. Click the Connect button.

### Access ACU through Network Communication (TCP/IP)

1. Connect your PC to the Management Port.
2. Select Network at communication type combo-box.
3. Enter in the ACU's IP address (Factory default : 192.168.2.1)
4. Enter in the ACU's port number (Factory default : 4002)
5. Click the Connect button then the Authentication window will appear.
6. Login by using the username and password below:
  - Username: intellian (Factory default)
  - Password: 12345678 (Factory default)

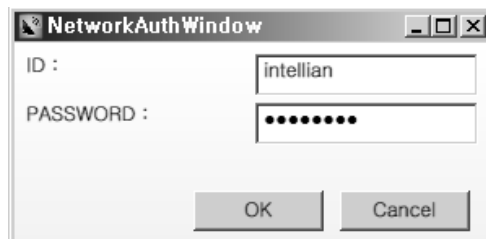

**NOTE:** If the remote access PC is located in the same network group with the ACU, the ACU can be accessed through the internal IP address. But, if the remote access PC is located outside of the network group, the ACU's IP address should be changed to the IP address assigned by the network service provider.



#### WARNING:

- Do not plug a USB to the ACU while TCP/IP communication is in use. Doing so will disable current PC Software Control because the USB connection has higher priority than TCP/IP connection.
- The amount of data will increase rapidly if Network Communication is in use. Intellian recommends using Aptus Web to access the ACU.

### AutoUpdate

Intellian Aptus® checks and notifies the latest version when it is started to maintain up to date software version by AutoUpdate function.

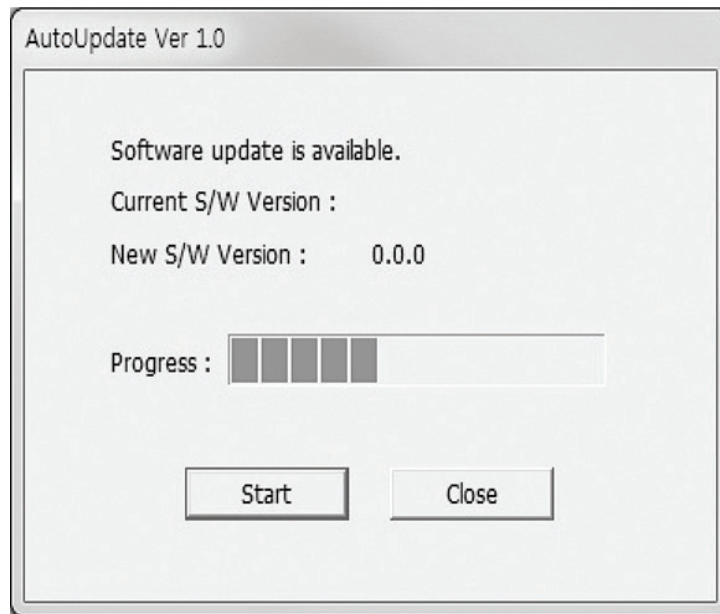

1. When Aptus® is started, it automatically checks the latest software version from the server and runs AutoUpdate if new version is available.
2. Current software version information is displayed.
3. It notifies new software version information.
4. When you click the “start” button, “File downloading...” message is displayed while downloading files from the server.

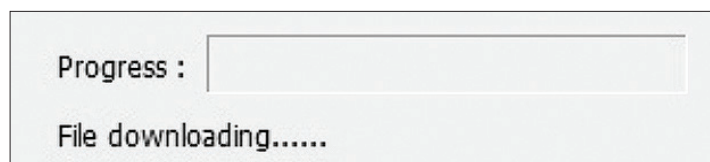

5. When file downloading is finished, “installing...” message is displayed and Aptus patch runs and the installation starts by InstallShield.
6. Click the “Finish” button when InstallShield installation is finished, then “Run the Aptus” message is displayed and Aptus runs and AutoUpdate is automatically finished.



# Toolbar Menus

The toolbar menus at the top of the screen display command buttons of the most commonly used functions of the Aptus®. The toolbar menu consists of 6 main menus; Quick (for quick launch of functions), File (for file backup, restoring and loading), View (for user layout and work view), Connection (for communication), Util (for firmware uploading and spectrum view) and Help (for reporting problems and information check).

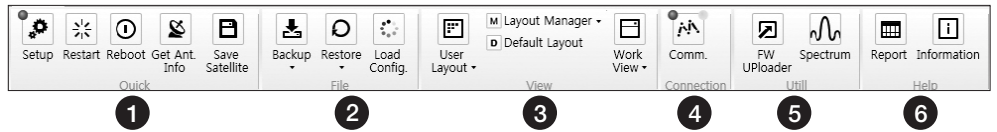

## 1 Quick



**Setup:** enters Setup mode.



**Restart:** exits Setup mode and restarts the antenna.



**Reboot:** reboots the antenna.



**Get Ant. Info:** obtains the information stored in the antenna



**Save Satellite:** saves the current bow offset only if the antenna is tracking onto the satellite. The satellite acquisition time can be reduced significantly after the antenna is restarted.

## 2 File

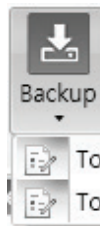

**Backup:** backups the antenna information to ACU or PC.

- Select 'To ACU' to backup the antenna information to ACU. The backup file (file format: \*.ibf) will be stored on the ACU.
- Select 'To PC' to backup the antenna information to a PC. The backup files (file format: \*.rpt and \*.ibf) will be generated on the PC.

**NOTE:** Both \*.rpt and \*.ibf files contain antenna information. However, while \*.ibf file can be used for restoring antenna information, \*.rpt file is stored as plain-text for viewing purpose only. Users can open the \*.rpt using text editors such as notepad software.

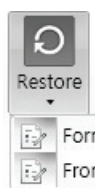

**Restore:** restores the antenna by using the stored information in ACU or PC.

- Select 'From ACU' to restore the antenna by using the stored information in ACU.
- Select 'From PC' to restore the antenna by using the stored information in PC (file format: \*.ibf).

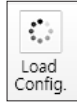

**Load Config. :** loads the antenna configuration file (file format: \*.cfg). The configuration file includes the antenna control parameters which are pre-loaded at the factory and should only be changed by an authorized service technician. Improper setting of these parameters will cause your system to perform improperly.

③ View



- **User Layout:** displays the layout list that the user has previously stored by using Layout Manager. If you select a layout in this list, the selected layout will be constructed in Work View screen. The 'Basic layout' is provided by default.

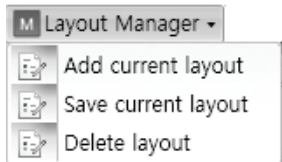

- **Layout Manager:** provides the user with add, delete, and save functionalities in order to manage the user's layouts.
  - Selecting 'Add current layout' opens a pop up window. Type in a desired name of current layout and click Add, then the new name of the current layout will be saved to the list under User Layout menu.
  - When changes are made to the current layout, select 'Save current layout' option. The current layout will be saved with changes.
  - To remove a layout, select 'Delete layout' option. Select a desired layout to remove on the pop up window, then click 'Delete'. Close the window by clicking on 'Close'. The selected layout is removed from the User Layout list.

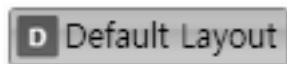

- **Default Layout:** returns the current layout to the default layout.

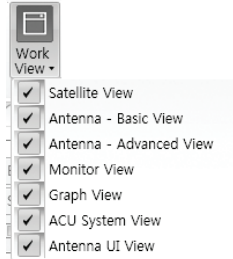

- **Work View:** displays a list of seven pre-constructed Work View Tabs (Satellite View, Antenna Basic View, Antenna Advanced View, Monitor View, Graph View, ACU System View, and Antenna UI View) and also provides the Activate / Close functionalities for each view tab. Activate the work view tab by ticking the checkbox next to it.

④ Connection

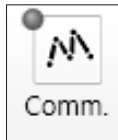

At any time, data communication channel can be re-established between Serial and Network connection. Selecting Comm. Button will display Communication Window to connect to the ACU via Serial or Network communication.

⑤ Util

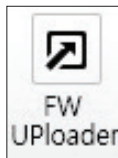

- **Firmware Uploader:** provides the user with the latest firmware version and updates firmware by simple steps.

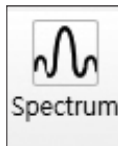

- **Spectrum:** displays current spectrum graph and allows to set spectrum data view options.

⑥ Help

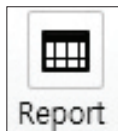

- **Report:** provides e-mail contact to Intellian technical support team to let the user report problems at any time.



- **Information:** displays the information of current Aptus® software version.

## System Property Status Dashboard

The property status dashboard on the left pane of the screen provides the antenna status, signal level, GPS and heading status, software information, product information and error status to be monitored quickly.

1 Antenna Status: Search 1  
Initialize → Search 1 → Tracking

2 Tracking Satellite  
● KOREA\_N A  
● KOREA\_F B

3 Signal Level 0 ●  
0

4 GPS ● 127.05 E 37.07 N  
Heading ● 1.00

5 Voltage  
Antenna : 23.9V  
ACU : 27.1V

6 Software Information  
Ant. PCU : V 4.00  
Ant. Stabilizer : V 4.00  
ACU Main : V 4.00  
Lib Version : V 1.15

7 Product Information  
System Model : T80W  
Ant. Name : T2-91AW2  
System Type:

8 Diagnostic Error Report

- ① Antenna Status: Displays the status of the current mode of the antenna.
- **Search 1:** A Search 1 pattern will automatically be initiated when the ship's heading input does not exist or if it fails. The search cycle will repeat until the antenna receives the lock signal from the receiver or until the DVB transponder of the target satellite is decoded by the antenna.
  - **Search 2:** Search 2 is reserved for future use.

- **Search 3:** Search 3 pattern will automatically be initiated when AGC falls below the current tracking level threshold value. Once the desired signal is found and above the predefined tracking threshold, the ACU will enter to tracking mode.
- **Tracking:** Antenna is tracking the target satellite.
- **Initialize:** Antenna or ACU is initializing.
- **Setup:** Antenna is in SETUP mode.

② Tracking Satellite  
 Display or set current tracking satellite and tracking information. Up to three satellites can be selected.

③ Signal Level  
 Shows “DVB” when DVB mode of tracking signal is in use. The “Red” line indicates the signal “Detect Level Threshold” and the “Orange” line indicates the signal “Tracking Level Threshold”. If the signal level is higher than the tracking level threshold, the signal level bar will display “Blue” color. If the signal level is lower than the tracking level threshold, the signal level bar will display “Orange” color and the antenna will stay in searching mode.

**NOTE:** If the signal level is not higher than the tracking threshold, decrease the detect and tracking level.

④ GPS and Heading  
 Displays the current GPS location from the Antenna and Ship’s heading information. The status light flashes green if the system receives a correct input of the GPS and Ship’s heading.

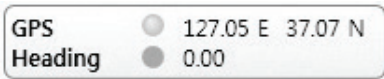

⑤ Voltage: Displays the antenna and the ACU voltage information.

⑥ Software Information: Displays the antenna and the ACU firmware versions, and the library version.

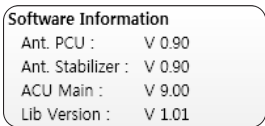

⑦ Product Information: Displays the antenna and ACU serial numbers, antenna model and ACU model.

⑧ Diagnostic Error Report  
 The square button next to the Diagnostic Error Report turns red when the system receives an error. Click the button to see a Diagnostic Report.

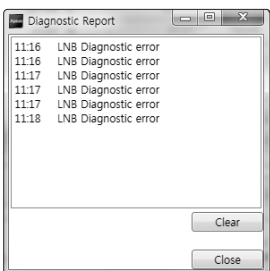

## Work View Tabs

Aptus® provides seven Work View Tabs (Satellite View, Antenna Basic View, Antenna Advanced View, Monitor View, Graph View, ACU System View, and Satellite View) to manage the Antenna and the Satellite configuration.

How to modify the settings on Work View;



1. Enter the Setup mode by clicking Setup icon.

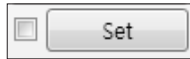

2. Tick the checkbox next to the “Set” button to modify the settings.
3. Enter the desired value then press the Set button to save the settings.

### 1. Antenna – Basic Info.

This view tab provides information on the Antenna’s Current GPS location, Heading Device, Bow Information, Skew Information, and the Antenna’s Angle. This view tab uses the Antenna’s AZ and EL information as well as the Ship’s Heading information in order to provide a dynamic graphic user interface (UI).

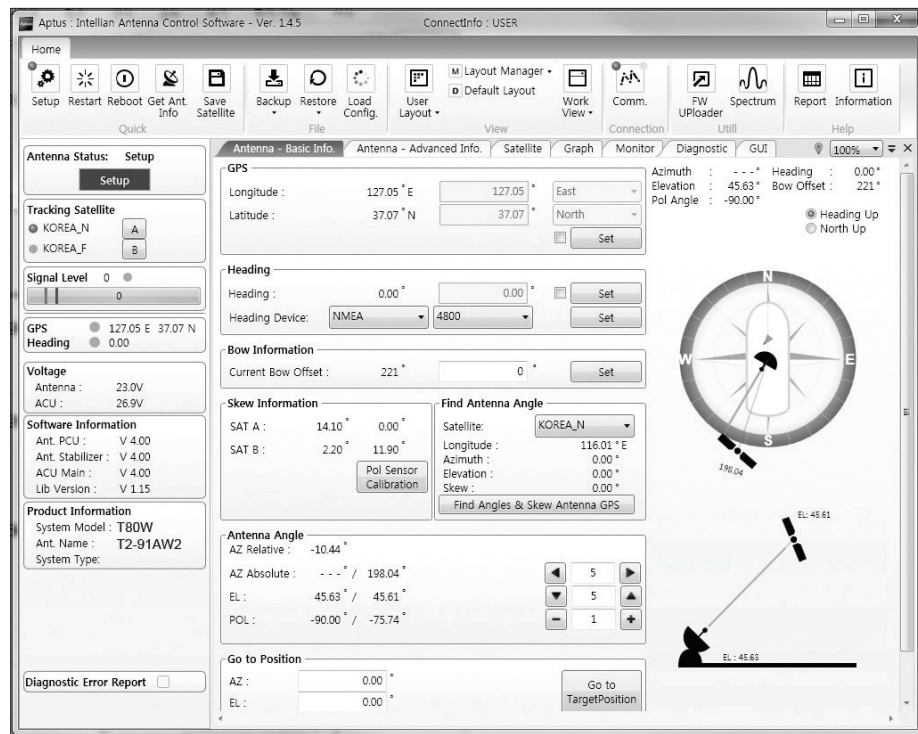

- **GPS:** displays and sets current antenna's GPS.
  
- **Heading:** displays and sets current ship's heading information.
  - Heading Device: None / NMEA/ NMEA 2000/Ground Test.  
The baud rate (4800/ 9600/ 19200/ 38400) must be set if NMEA is selected.
  
- **Bow Information:** displays and sets current antenna's bow.
  
- **Skew Information:** displays current antenna's skew and skew offset for the selected satellites.
  - Pol Sensor Calibration: calibrates the sensor (potentiometer).
  
- **Find Antenna Angle:** displays and sets the current antenna angle. Select a desired satellite from the drop-down menu, then longitude, azimuth, elevation and skew information are displayed.
  - Find Angles & Skew Antenna GPS: Finds the current antenna angles and skew angle in relation to the longitude (orbit position) of the antenna's current GPS.
  
- **Antenna Angle:** displays and sets current antenna's absolute and relative AZ (azimuth) position, EL (elevation) position and polarization (between Linear and Circular). You can move antenna azimuth and elevation position and LNB Pol angle by using the arrows or inputting a value to find the desired satellite manually.
  
- **Go to Position:** The current position (angle) of the antenna is displayed. Push the "Go to target Position" button after keying in the desired angle to move the antenna to target position.

**2. Antenna – Advanced Info.**

This view provides information on the Tilt Sensor Bias, Rate Sensor, Conical Range, Parameter Setting, Threshold Setting, Search Parameter and Flag Setting.

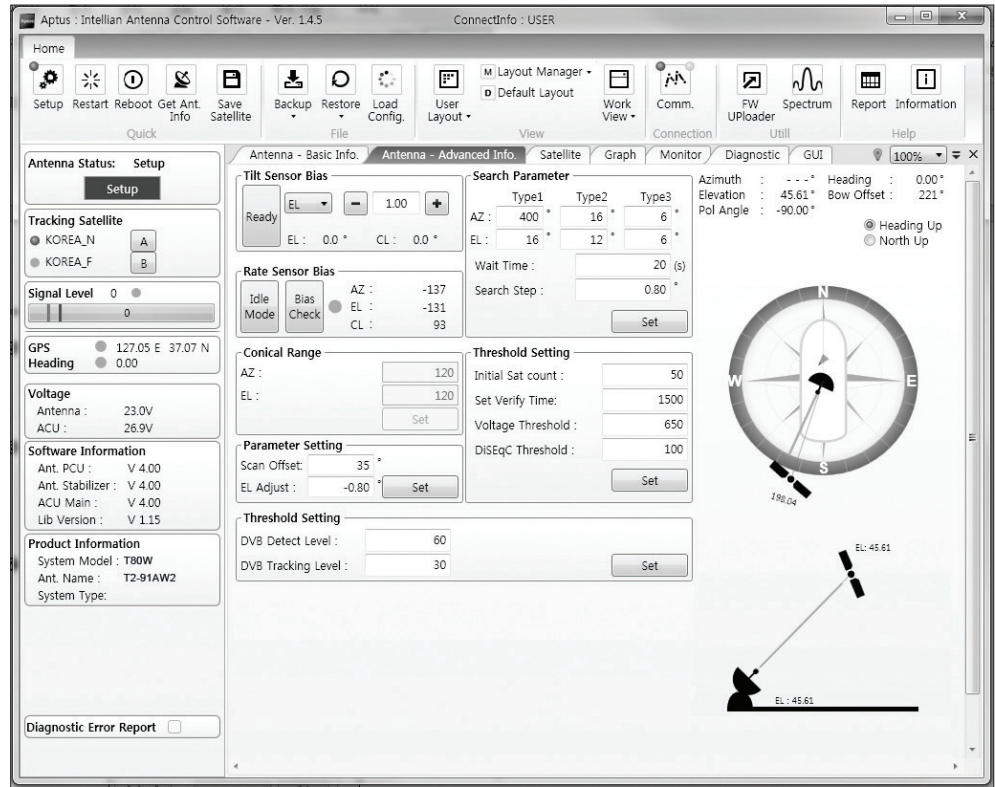

**-Tilt Sensor Bias:** This maintains the elevation and the cross level axes in order to keep the pedestal parallel to the horizon. Adjust the two solid-state tilt sensors to provide absolute cross-level tilt of the antenna and elevation feedback to eliminate long-term pointing drift (error). Tilt bias must be adjusted when the antenna control board or sensor box is replaced. If the bubble on the button level located on the sensor box is not centered, follow the following steps to adjust the tilt sensor bias.

- Step 1. Enter Setup mode and press the “Ready” button to bring the elevation and cross-level to 0.
- Step 2. Select “EL” from the drop down list and press Up and Down arrow keys to adjust the bubble until it is located in the center ring of the button level.
- Step 3. Select “CL” from the drop down list and press Up and Down arrow keys to adjust the bubble until it is located in the center ring of the button level.





- Step 4. Press the “Restart” icon to restart the antenna.

- **Rate Sensor:** is used to calibrate the DC voltage output from the three rate sensors (azimuth, elevation, and cross-level). These are used to sense antenna motion that corresponds to the ship’s motion (roll, pitch, and yaw) for stabilizing the pedestal. The DC voltage output from each of the rate sensors may vary by an amount which is directly proportional to the direction and rate of motion induced on it.

Before calibrating the rate sensors located in the Sensor box, make sure that the antenna is placed on a rigid and flat platform. During the calibration process, any motion of the antenna should be avoided as it can affect the antenna’s performance. Proceed with the following steps to perform the calibration.

- Step 1. Enter Setup mode
- Step 2. Press the “Idle Mode” button to release the elevation and cross level motor brakes while the antenna is in Setup mode.
- Step 3. Check whether or not the bubble is located at the center of the button level. If not, move it to the center by following the previous instruction of Tilt Sensor Bias adjustment.
- Step 4. Press the “Bias Check” button to calibrate the rate sensor. A blue circle will be displayed next to the Bias Check button if the calibration is completed. A red circle will be displayed if calibration failed. A green circle will be displayed during the calibration process.

- **Parameter Setting: used to set the control parameter settings.**

- Scan Offset: The scan offset is to offset the angle difference between the black marker on the sub-reflector and the optical sensor
- EL Adjust: The elevation adjustment is to offset the angle difference between the mechanical elevation angle and actual elevation angle.

- **Threshold Setting:** set the threshold level for detecting and tracking the satellite signal.

- DVB Detect Level: displays and sets signal detection threshold level when DVB tracking mode is in use.
- DVB Tracking Level: displays and sets signal tracking threshold level when DVB tracking mode is in use.

- **Search Parameter:**

- Wait time: set the time-out for automatic initiation of a search after the signal level drops below the pre-defined threshold value.
- Search Step: set increment step size.
- Type 1 & Type 3 (Search 1 & 3) Range: set Search 1 & 3 search range. Search 3 is conducted in a two-axis pattern consisting of alternate movements in azimuth and elevation as it forms an expanding square.
- Type 2 (Search 2) Range: is reserved for future use.

- **Threshold Settings**

- Initial Sat Count: Set the threshold count for maintaining tracking.
- WRS Detect Level: Set the WRS detection level.
- Voltage Threshold: Set the voltage threshold. The voltage threshold is to distinguish the voltage between 13V and 18V.
- DiSEqC Threshold: Set the DiSEqC threshold. The DiSEqC threshold is to distinguish the 0KHz tone and 22KHz tone.

- **Flag Settings**

- Use WRS Method: Use WRS method is to determine whether the system uses “WRS Detect Level” or not. Use WRS method and “WRS Detect Level” are pair functions.
- Use Offset Difference: Use offset difference is to determine whether the system uses “Offset Difference” or not. Use Offset Difference and “Offset Difference” are pair functions.

### 3. Satellite (Satellite View)

The name, longitude, Skew Offset, Polarity, verification method of the satellite and local frequency are displayed. Tick the “Edit Satellite” box to edit the satellite information. After modifying the value.

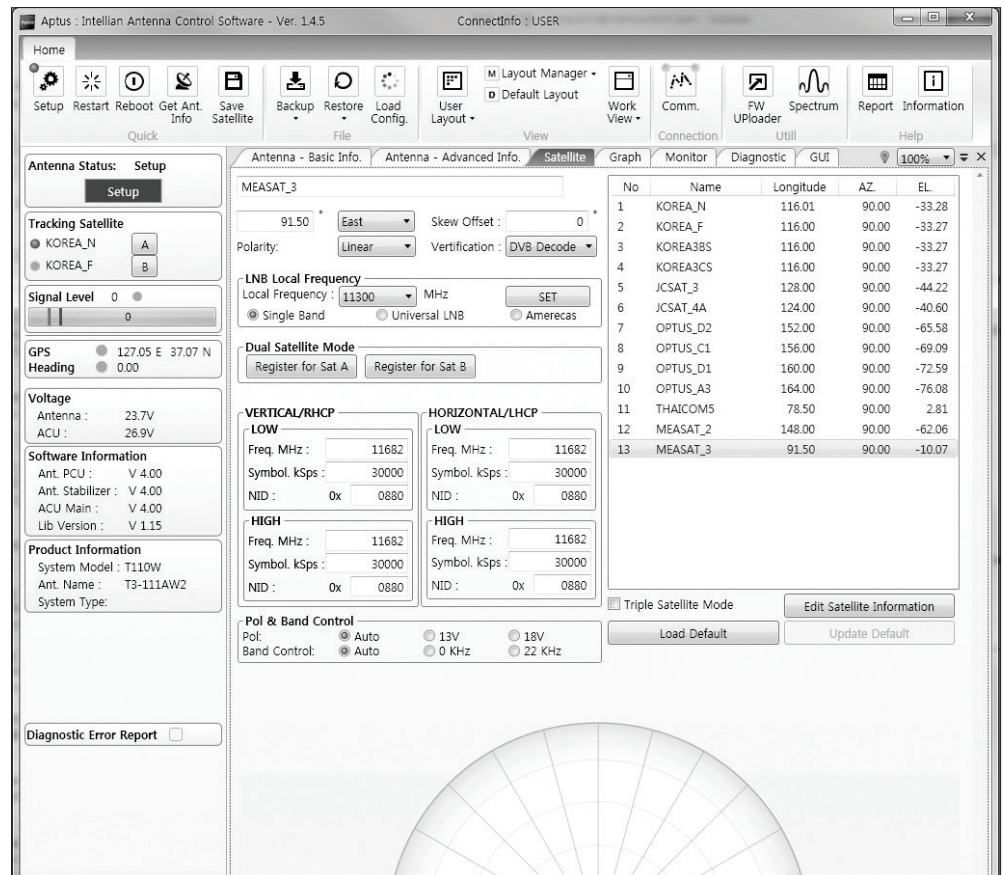

- **LNB Local Frequency:** Displays or sets LNB local frequency and its corresponding LNB voltage supplied. You may select pre-programmed LNB LO settings from the drop down list. This procedure is same for both the Intellian Global VSAT PLL LNB and any other LNB.

#### - Transponder Information

- Register for Sat A & Register for Sat B: register the selected satellite for A or B.
- Transponder information consists of frequency, symbol and NID (Network ID) of a transponder in tracking the satellite. There are four groups of transponder information. ‘Vertical/RHCP’ is applied when the IRD supplies 13V, and ‘Horizontal/LHCP’ is applied when the IRD supplies 18V. ‘LOW’ is applied when DiSEqC signal is not detected from IRD. ‘HIGH’ is applied when the DiSEqC signal is detected from the IRD. After modifying information, press the ‘Edit Satellite Information’ button, then new information is updated in the antenna.

- **Pol & Band Control:** The “Pol” controls 13V (Vertical/RHCP band) or 18V (Horizontal/ LHCP band). The “Band” controls DiSEqC 0KHz tone (Low band) and 22KHz tone (High band). After modifying information, press ‘Edit Satellite Information’ button, then new information is updated in the antenna.
  
- **Triple Satellite Mode:** To select between Dual-Sat mode and Triple-Sat mode, tick the 'Dual Satellite Mode' box or 'Triple Satellite Mode' box at the bottom of the screen.
  
- **Edit Satellite Information:** push the “Edit Satellite Information” button to update the information after modifying values.
  
- **Load Default:** Push the "Load Default" button to select a regional library file \*.rif according to your region.
  
- **Update Default:** After loading a regional library file \*.rif, push the "Update Default" button to update the system.

#### 4. Graph View

This view provides information on Signal, Elevation (EL), Absolute AZ (Azimuth), Relative AZ, Heading, AZ and EL in Single or Multi graph formats.

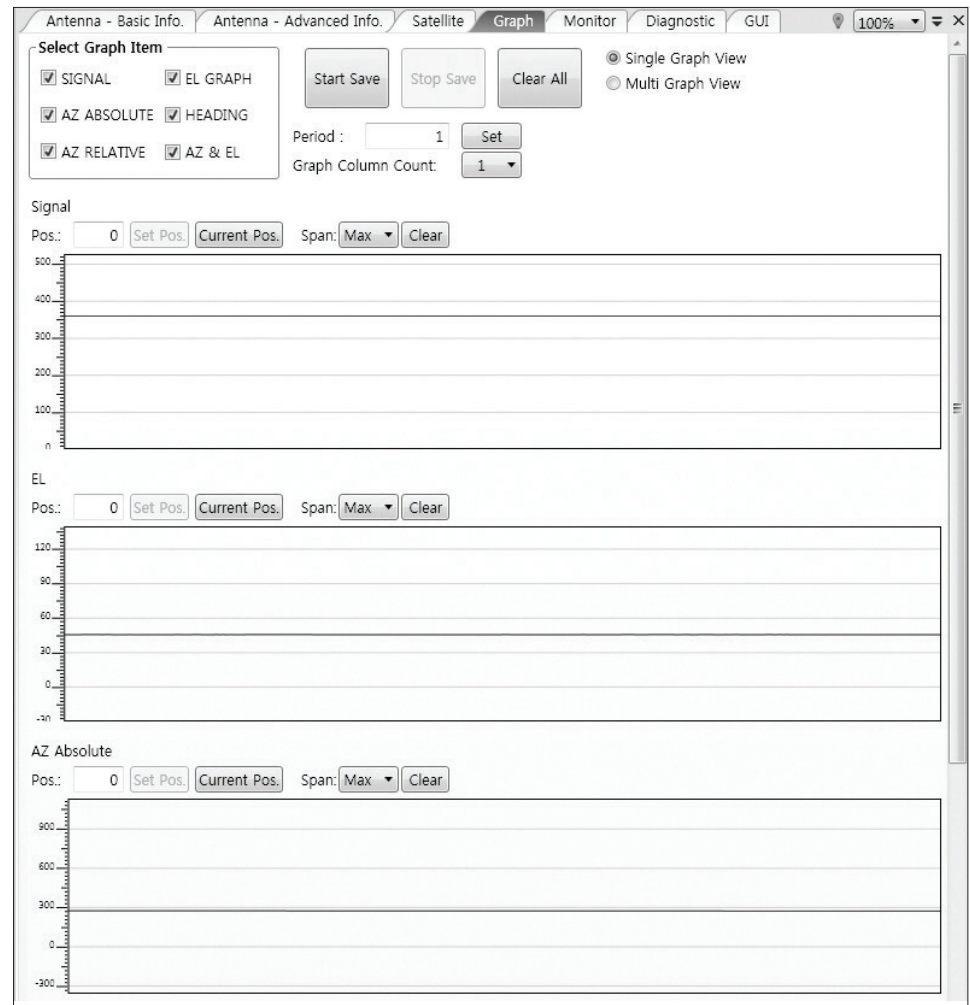

- **Select Graph Item:** shows the graphs of only the checked item(s) in a Single or Multi Graph View.
- **Single Graph View:** shows Graph Views per each single Graph Item selected in 'Select Graph Item'.
- **Multi Graph View:** shows one large integrated Graph View of multiple Graph Items selected in 'Select Graph Item'.
- **Start/Stop Save:** the chosen item is saved within the data log. The data log which stores the information displayed in the graphs can be later used for a service technician to find out a cause of any possible problem to the antenna.
- **Clear All:** clears everything drawn on the Graph View window.

- **Set Pos.:** sets the current position as center value of each Graph Item.
- **Current Pos.:** moves to the location according to values of each Graph Item.
- **Span:** sets the Display Range(s) of each corresponding Graph Item.
- **Period:** displays and sets the signal sampling rate.
- **Graph Column Count:** makes all Graph Views show in either one or two-column format.

**5. Monitor**

This view provides a UI which can monitor all data that has been received from the ACU.

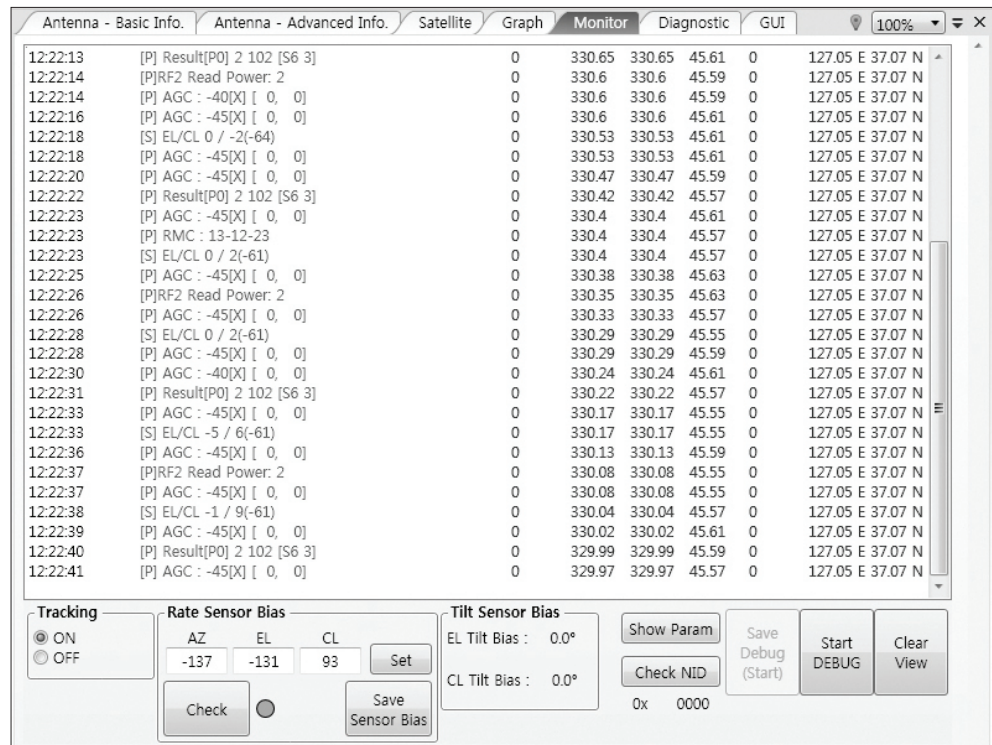

- **Tracking:** turns on or off the dish scan function. If the dish scan function is disabled, the antenna will stop adjusting the antenna pointing angle in order to optimize the receive signal level.

- **Rate Sensor Bias:** is used to calibrate the DC voltage output from the three rate sensors (azimuth, elevation, and cross-level). These are used to sense antenna motion that corresponds to the ship's motion ( roll, pitch, and yaw) for stabilizing the pedestal. Push the "Check" button to check the EL and CL Tilt Bias.
- **Show Param:** shows the current antenna parameters.
- **Check NID:** verifies the NID (network ID) of the current tracking transponder. Press the NID button to obtain the NID only if the antenna is locked onto the desired satellite .
- **Debug (Start):** starts the debug log of the antenna. The debug message will be displayed once the debug button is pressed.
- **Stop Debug:** stops debug logging of the antenna.
- **Save Debug (Start/Stop):** starts or stops saving the debug log. This button is enabled once the Start Debug button is pressed.
- **Clear View:** clears the debug message or log data in monitoring window.

## 6. ACU System

This view provides Antenna Diagnostic Testing.

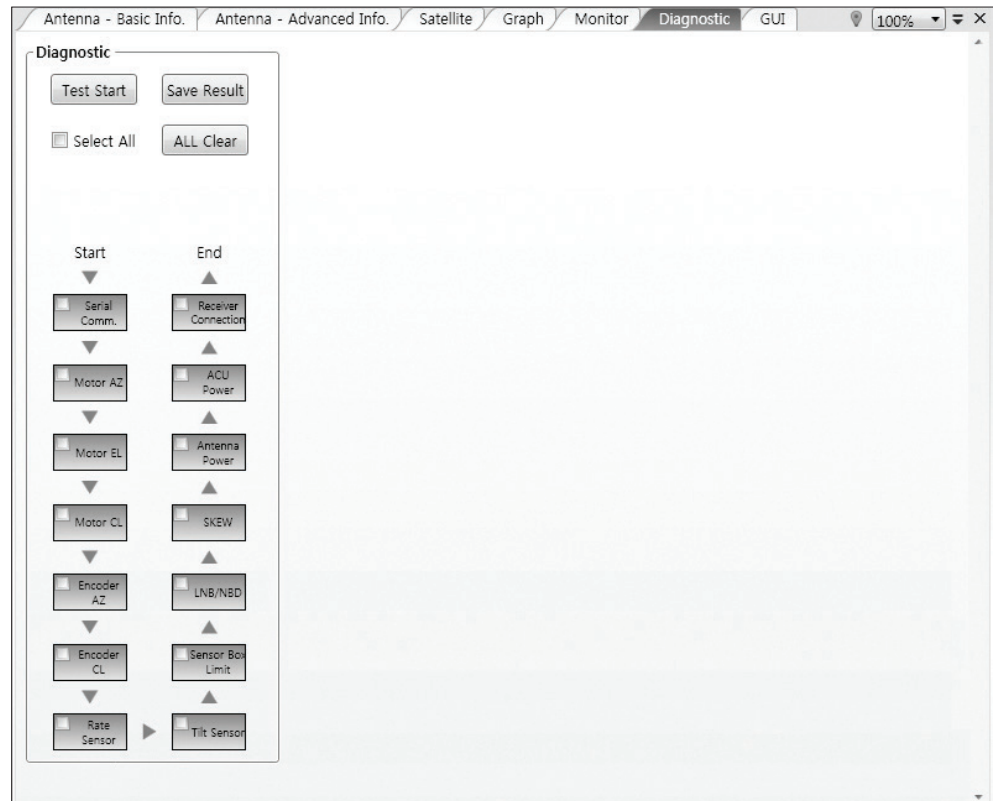

- **Diagnostic** : select to run a full diagnostic test or single diagnostic test. "Green" indicator is displayed for the test under progress. "Blue" indicates the test result as Pass while "Red" indicates the result as Fail. "Yellow" indicates the test has been skipped.

- **Serial Comm.:** tests the data communication between the antenna and the ACU.
- **Motor AZ:** tests the azimuth motor.
- **Motor EL:** tests the elevation motor.
- **Motor CL:** tests the cross-level motor.
- **Encoder AZ:** tests the azimuth encoder.
- **Encoder CL:** tests the cross-level encoder.
- **Rate sensor:** tests the rate sensor.
- **Tilt Sensor:** tests the tilt sensor.
- **Sensor Box Limit:** tests the sensor box motor.
- **LNB/ NBD:** tests the LNB. (NBD is not available on this model.)
- **Skew:** tests the LNB skew motor.



- **Antenna power:** tests the antenna power to see whether or not it is within the nominal operating range.
- **ACU power:** tests the ACU power to see whether or not it is within the nominal operating range.
- **Receiver Connection:** tests the data communication between the antenna and the receiver.

### 7. Work View Functions

The seven Work View Tabs displayed in the Work View can be arranged in customized layouts.

#### - Layout Formatting

- Each of the Work View Tab can be separated from the rest Tabs. Click and hold the left mouse button on the Work View Tab's header and then drag a desired Tab out. When a Work View Tab is separated from the rest of your Work View Tabs, again click and hold the left mouse button on the Work View Tab's header to display a cross-shaped Navigator icon. While holding the mouse button, bring the selected Work View Tab closer to the Navigator icon and release the mouse button at your desired position (top, left, right or bottom arrow). This time, the selected Tab will be moved to the desired position.

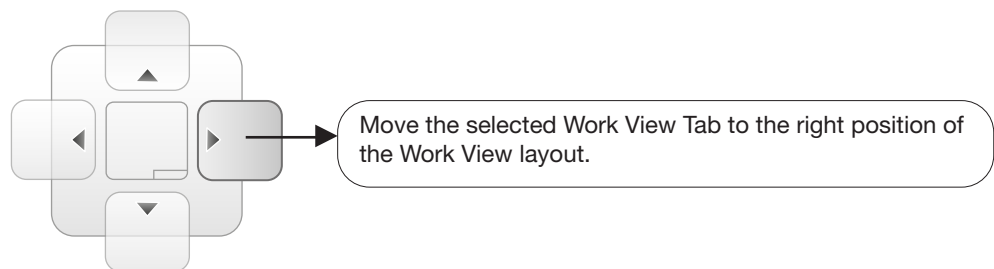
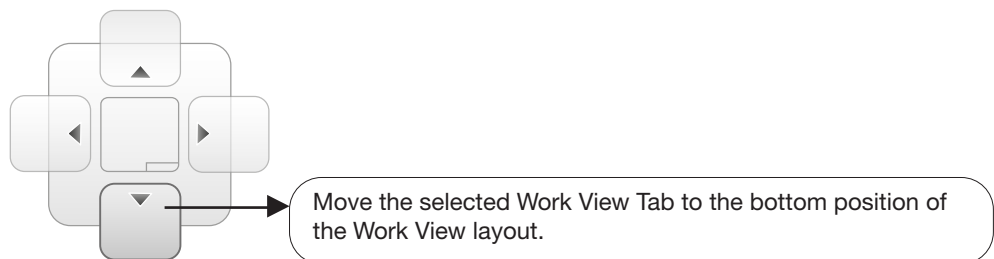
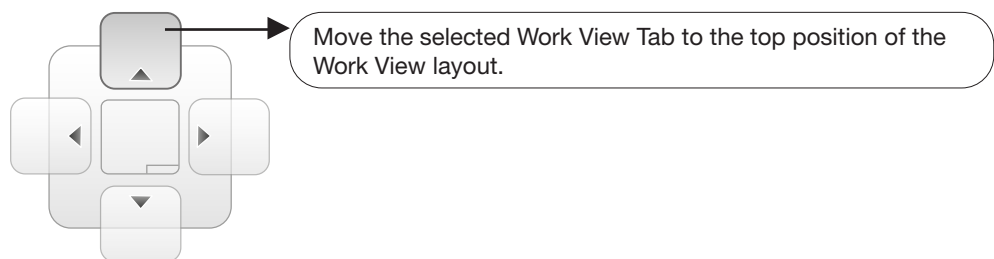

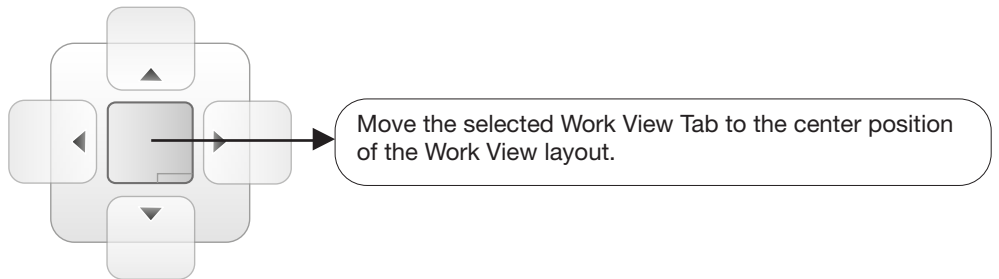
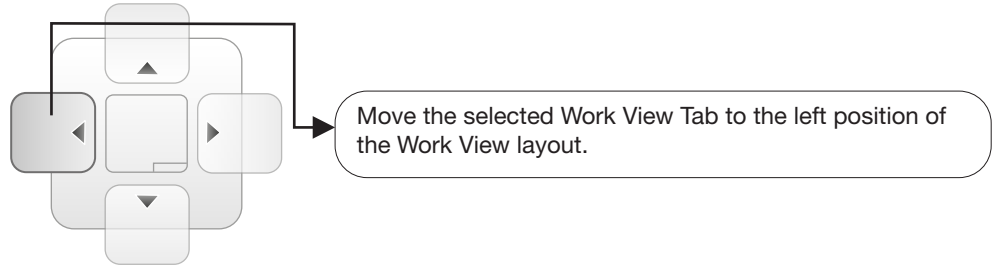

**- Horizontal or Vertical Tab Group**

The Work View Tabs can be also aligned horizontally or vertically. Without dragging them out, right-click the mouse button on a desired Tab header and select 'New Horizontal Tab Group' or 'New Vertical Tab Group' option. Selecting 'New Horizontal Tab Group' will separate a selected Tab from the rest of other Tabs then arrange it in a horizontal format. Likewise, selecting 'New Vertical Tab Group' will separate a selected Tab from the rest of other Tabs then arrange it in a vertical format.

**- Closing the Work View Tab**

To close the Work View Tab, right-click the mouse button on a desired Tab header and select 'Close' option in the drop down list. To close all Work View Tabs except the selected Tab, select 'Close All But This' option in the drop down list.

**- Zoom Tool**

Using the Zoom tool, you can easily select the magnification you want by using Zoom In and Zoom Out bar, and Fit in Work View button.



Fit Work View Button: fits the current view to the Work View window size. The button toggles between the fit view and the previous view.

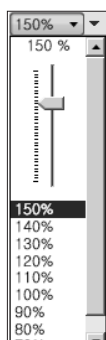

Zoom In and Zoom Out Bar: zooms in and out to expand and reduce the View to the desired size. (The zoom changes in 10% increments.)



View Switch Button: displays a list of the current views in a list. Choosing one of these views will display the selected view in the Work View window.



View Name Button: displays the current Work View name.



Close View Button: closes the current view.



# APTUS WEB

## Introduction

## Main Page

Page Login  
Top menus  
Dash Board & Information

## Antenna Settings

Ship setting  
Antenna Position & Parameters  
Tracking setting  
Diagnostic

## Firmware & Configuration

Antenna Firmware Upgrade  
Antenna Log  
Antenna Backup & Restore

## Administration

Network Setting  
SNMP Setting  
User Management  
iARM Upgrade  
iARM Save & Reboot  
Antenna Event Log  
Intellian Network Devices

## Introduction

With embedded Aptus Web, the antenna can be monitored, controlled, and diagnosed remotely from anywhere, anytime through the TCP/IP protocol. This not only can save time but also save the cost generated from routine maintenance activities such as operating firmware upgrades, tracking parameters resets, and system diagnostic.

### How to access Aptus Web

1. Connect an Ethernet Cable between your PC and the Management Ethernet Port.
2. Enter the ACU's IP address (192.168.2.1) into your web browser's address bar to login into the ACU's internal HTML page, if this system has not been changed from the ACU's factory default.

**NOTE:** Aptus Web can be displayed in Internet Explorer 7 or later and is also compatible with Firefox and Chrome web browsers.

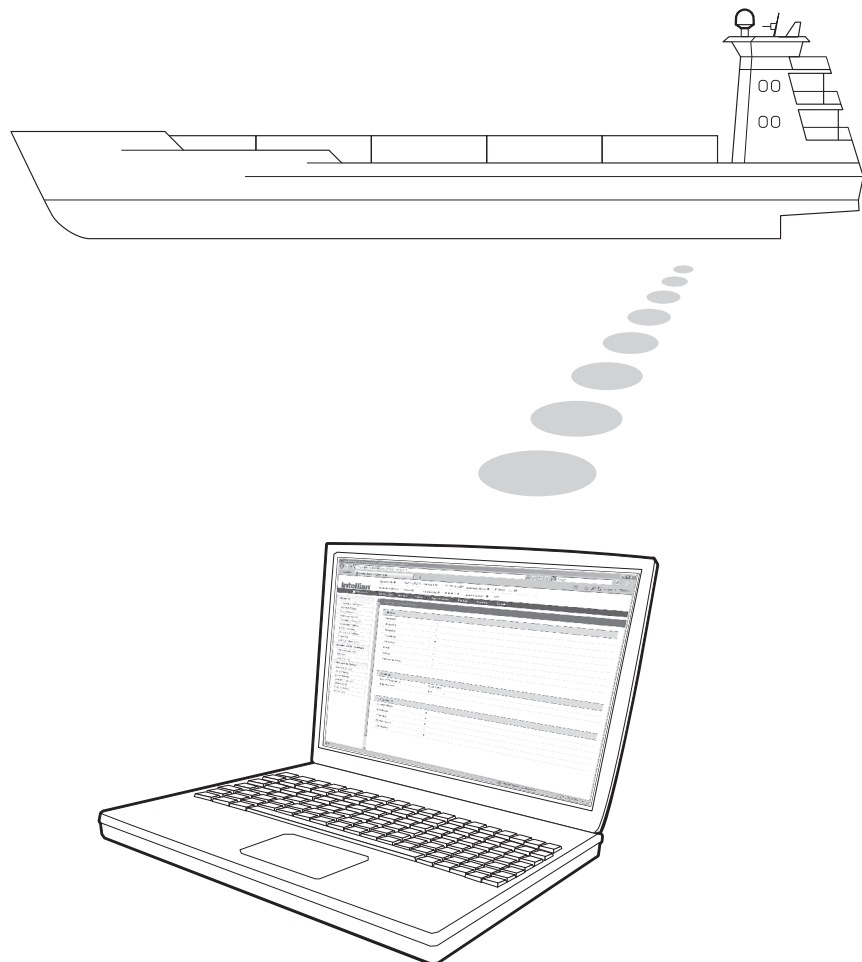



## Main Page

### Page Login

1. Choose either to Control & Monitor the ACU (Control & Monitoring) or Only Monitor the ACU (Monitoring Only).
2. Log into the ACU by typing in User Name and Password information. If this system has not been changed from the factory default:

- **User Name:** intellian
- **Password:** 12345678

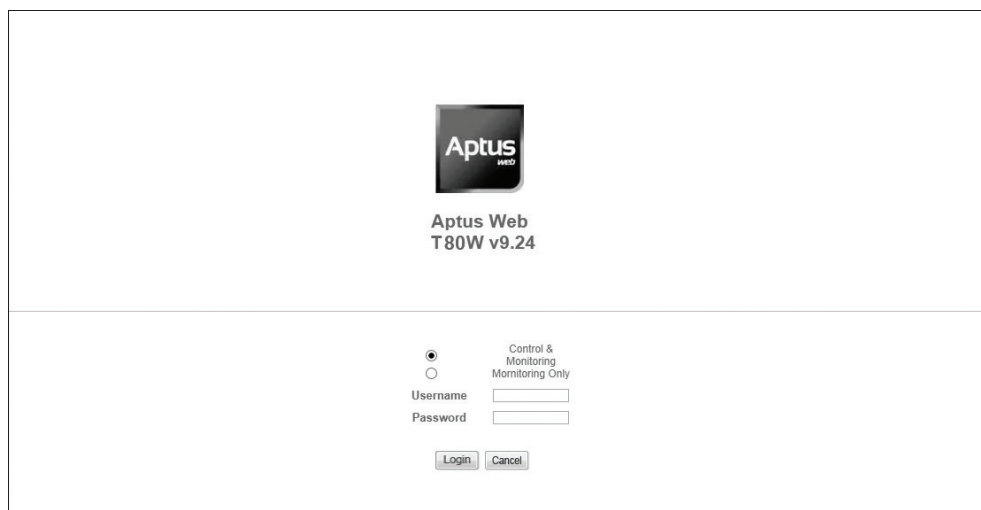

Aptus Web  
T80W v9.24

Control & Monitoring  
 Monitoring Only

Username

Password



**WARNING:** The Control & Monitoring Mode will be switched to the Monitoring Only Mode in the following cases;

- If PC Software (Aptus) is connected using TCP/IP Communication while APTUS WEB Control is in use.
- If APTUS WEB Control & Monitoring Mode is accessed while PC Software is running via TCP/IP Communication. In this case, the web page will display a pop-up message asking if you want to disconnect the PC Software network connection. If you select 'No', the Control & Monitoring Mode will be switched to the Monitoring Only Mode.

### Top Menus

Once you log in, the following information and menus are displayed.

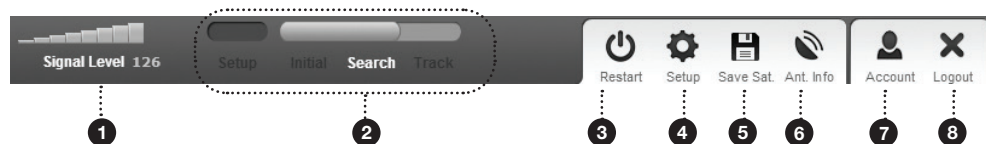

No.	Item	Description
①	Signal Level	Display current signal level.
②	Antenna status	<ul style="list-style-type: none"> <li>- Setup: Displays whether or not the antenna is in SETUP mode. The indicator shows “Blue” in the SETUP mode.</li> <li>- Initial: Antenna or ACU is initialized.</li> <li>- Search: Antenna is searching a target satellite.</li> <li>- Track: Antenna is tracking the target satellite.</li> </ul>
③	Restart	Restart the antenna system.
④	Setup	Enter SETUP mode.
⑤	Save Sat.	Save current satellite settings. Bow offset will be adjusted and saved automatically.
⑥	Ant. Info	Obtain current antenna information.
⑦	Account	Shortcut to User Management menu. Change login ID and Password.
⑧	Logout	Logout the ACU's internal HTML page.

### Dash Board & Information

On the left side of the page, Dash Board and Information menus are displayed as below to provide quick monitoring of the antenna status and settings. Other menus are displayed only in the Control & Monitoring mode and their functions will be described in the next sections.

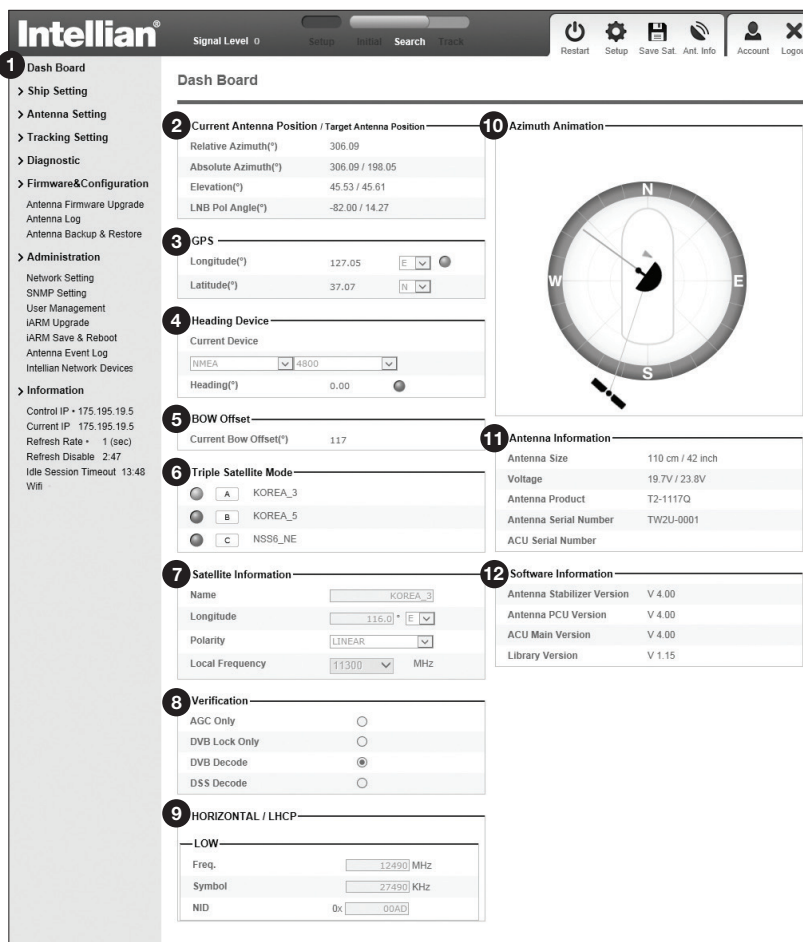

No.	Item	Description
①	Dash Board	Displays current antenna status to be quickly monitored.
②	Current Antenna Position / Target Antenna Position	Displays current antenna position. - Relative Azimuth: displays antenna relative AZ angle. - Absolute Azimuth: displays antenna absolute AZ angle. - Elevation: displays antenna elevation angle. - LNB Pol Angle: displays LNB pol angle.
③	GPS	Displays current GPS information. - Longitude (East / West) - Latitude (North / South)
④	Heading Device	Displays current Heading Device: NONE, NMEA, NMEA 2000, Ground test If the ship's gyrocompass input is other than NMEA separate purchase of NMEA Converter is required. - Heading: displays ship's heading information.

⑤	BOW Offset	Displays current bow offset
⑥	Triple Satellite Mode	Mode: Select between Dual-Sat mode and Triple Sat mode.
⑦	Satellite Information	Displays the satellite name, longitude, polarity and LNB local frequency of the current satellite.
⑧	Verification	Displays current verification method for satellite tracking.
⑨	Tracking Information (Frequency band)	Displays current frequency band that consists of frequency, symbol and NID (Network ID) of a transponder in tracking the satellite.
⑩	Azimuth Animation	Shows a graphical representation of the current antenna position to identify whether or not the antenna is aligned properly to the target satellite or is in a block zone.
⑪	Antenna Information	Displays the product information
⑫	Software Information	Displays current Antenna and ACU firmware versions and Satellite Library version installed in the system. - Antenna Stabilizer Version - Antenna PCU Version - ACU Main Version - Library Version

---

# Antenna Settings

## Ship Setting

No.	Item	Description
①	Ship Setting	Set the ship information and find antenna angle.
②	GPS	Set GPS information. - Longitude (East/West) - Latitude (North/South)
③	Bow Offset	Set Bow Offset if needed.
④	Heading Device	Set ship's heading device (NONE, NMEA, NMEA2000, Ground Test) and ship's heading information
⑤	Antenna Angle	Find the current antenna angles and skew angle in relation to the longitude (orbit position) of the antenna's current GPS. Click 'Find Angles & Skew Antenna GPS' button.



WARNING

**WARNING:** Enter the SETUP mode for configuration. Tick the checkbox before modifying the settings. After configuration, click 'Set ...' button to submit the settings.

### Antenna Position & Parameters



No.	Item	Description
①	Antenna Setting	Set current antenna position and Search and Tracking parameters. These parameters should only be changed by an authorized service technician. Improper setting of these parameters will render your system inoperable.
②	Current Antenna Position/ Target Antenna Position	Display current antenna position. - Relative Azimuth: display antenna relative AZ angle. - Absolute Azimuth: display antenna absolute AZ angle. - Elevation: display antenna elevation angle. - LNB Pol Angle: display LNB pol angle. - Heading: display ship’s heading information.
③	Manual Movement	Move antenna azimuth and elevation angles and LNB pol angle to find the desired satellite manually. LNB Pol Angel can be adjusted at any time either in SETUP Mode or Tracking Mode.
④	LNB Pol Sensor Calibration	Calibrate the LNB pol angle when the control board, potentiometer or LNB Assembly is replaced.

⑤	Elevation Adjust	Adjust the elevation to offset the angle difference between the mechanical elevation angle and actual elevation angle.
⑥	Idle Mode	Release the elevation and cross level motor brakes while the antenna is in SETUP mode. The antenna can be moved manually during the mode.
⑦	Reboot	Reboot the system.
⑧	Flag Setting	Set the flag settings. Select 'Use WRS Method' to use 'WRS(Wide Range Search) Detect Level'. Select 'Use Offset Difference' to enable the system to offset the signal difference between RHCP and LHCP.
⑨	Search & Tracking Parameter Setting	<ul style="list-style-type: none"> <li>- Detect Level Threshold: display / set current detect level threshold to set the satellite signal detection level.</li> <li>- Tracking Level Threshold: display /set current tracking level threshold to set the satellite signal tracking level.</li> <li>- Wait Time: set the time-out for automatic initiation of a search after the signal level drops below the pre-defined threshold value.</li> <li>- Search Step: set increment step size</li> <li>- Search 2 Range: is reserved for future use</li> <li>- Search 1 Range: set Search 1 search range. The antenna is detecting the satellite signal which is above the current detect level threshold. The search range corresponds to Search Type 1. Once the signal is located, the antenna will enter to "Search 3 mode".</li> <li>- Search 3 Range: set Search 3 search range. The antenna is detecting the satellite signal which is above current tracking level threshold. The search range corresponds to Search Type 3. Once the signal is located, the antenna will enter "Tracking mode".</li> </ul>
⑩	Tilt Sensor Bias	Adjust the two solid-state tilt sensors used to provide absolute cross-level tilt of the antenna and elevation feedback to eliminate long-term pointing drift (error). Tilt bias is required to be adjusted when the antenna control board or sensor box is replaced. Check to see whether or not the bubble is located at the center of the level vial.
⑪	Rate Sensor Adjust	Calibrate DC voltage output from the three rate sensors used to sense antenna motion in azimuth, elevation and cross-level axes. During the calibration process, the antenna should avoid any motion as it can affect the antenna's performance.

⑫ Parameter Setting

- 
- Initial Sat Count: Set the threshold count for maintaining tracking.
  - WRS Detect Level: Set the WRS detection level.
  - Voltage Threshold: Set the voltage threshold. The voltage threshold is to distinguish the voltage between 13 V and 18V.
  - DiSEqC Threshold: Set the DiSEqC threshold. The DiSEqC threshold is to distinguish the 0KHz tone and 22 KHz tone.
  - Sat Verify Time: Set the threshold count for the satellite verification.
  - Tracking Stable Count: Set the threshold count for stabilizing the satellite before tracking.
  - Offset Diff AZ-EL: Set the offset difference between Azimuth and Elevation range.
  - Search Lock Count: Set the threshold count for locking on the satellite before tracking.
  - Offset Diff RH-LH: Set the offset difference between RHCP and LHCP signals.
- 



**WARNING:** Tick the checkbox before modifying the settings. After configuration, click 'set...' button to submit the settings.



## Tracking Setting

No.	Item	Description
①	Tracking Setting	Display or set current tracking satellite and tracking information.
②	Tracking Satellite	Select the tracking satellite.
③	Triple Satellite Mode	Register the selected satellite in Tracking Satellite for Sat A, Sat B or Sat C. To select between Dual-Sat mode and Triple-Sat mode, press the 'Dual Satellite Mode' button or 'Triple Satellite Mode' button on the bottom of the screen.
④	Satellite Information	Set the satellite name, longitude, polarization and local frequency of LNB to be used.
⑤	Verification	Set the verification type for satellite tracking (AGC Only, DVB Lock Only, DVB Decode, DSS Decode)
⑥	Tracking Information	Tracking information consists of frequency, symbol and NID (Network ID) of a transponder in tracking satellite. There are four groups of tracking information. "Vertical/RHCP" is applied when IRD supply 13V, and "Horizontal/LHCP" is applied when IRD supply 18V. "LOW" is applied when DiSEqC signal (0 kHz tone) is not detected from IRD. "HIGH" is applied when DiSEqC signal (22 kHz tone) is detected from IRD.  Pol & Band Control: The "Pol" controls 13V (Vertical/RHCP band) or 18V (Horizontal/ LHCP band). The "Band" controls DiSEqC 0KHz tone (Low band) and 22KHz tone (High band)  After modifying information, press 'Edit Satellite Information' button, then new information is updated in the antenna.

## Diagnostic

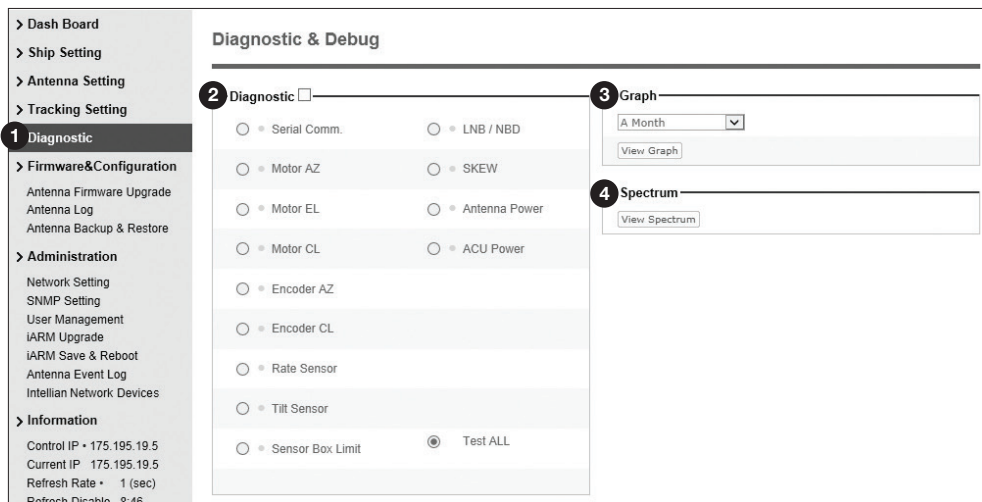

No.	Item	Description
①	Diagnostic	Execute antenna diagnostic test.  Select to run a full diagnostic test or single diagnostic test.  - Serial Comm.: test the data communication between the antenna and the ACU. - Motor AZ: test the azimuth motor. - Motor EL: test the elevation motor. - Motor CL: test the cross-level motor. - Encoder AZ: test the azimuth encoder. - Encoder CL: test the cross-level encoder. - Rate Sensor: test the rate sensor. - Tilt Sensor: test the tilt sensor. - Sensor Box Limit: test the sensor box motor. - LNB/NBD: test the LNB. - SKEW: test the LNB pol motor. - Antenna Power: test the antenna power. - ACU Power: test the ACU power.
③	Graph	Select to view a graph of AZ Absolute, AZ Relative, EL and Heading data of the antenna.  - A Month: display all data within a month - A Week: display all data within a week - A Day: display all data in a day - Real-time: display data in real time. Press F5 button to refresh. - Data Num: set the maximum number of graph data set to be displayed. - View Graph: select to view the data graph.
④	Spectrum	Select to view a current spectrum graph and to set the spectrum.



**WARNING:** Tick the checkbox before modifying the settings. Click Diagnosis button to execute diagnostic test. To clear previous diagnosis result, click Diagnosis Clear button.

# Firmware & Configuration

## Antenna Firmware Upgrade

- > Dash Board
- > Ship Setting
- > Antenna Setting
- > Tracking Setting
- > Diagnostic
- > Firmware&Configuration
- Antenna Firmware Upgrade
- Antenna Log
- Antenna Backup & Restore
- > Administration
  - Network Setting
  - SNMP Setting
  - User Management
  - iARM Upgrade
  - iARM Save & Reboot
  - Antenna Event Log
  - Intellian Network Devices
- > Information
  - Control IP \* 175.195.19.5
  - Current IP 175.195.19.5
  - Refresh Rate \* 1 (sec)

### Antenna Firmware Update

---

**2. New Antenna Firmware**

Browse and select the firmware file to upload. 찾아보기...

The update may take a few minutes to complete.  
The upload time may vary due to a variety of factors such as the speeds of your network.  
Upload an incorrect firmware file may cause serious damage to your antenna and ACU.

Start Upload Cancel

**3. Current Running Version**

Current Firmware Version	Antenna STABILIZERv4.00
	Antenna PCU v4.00
	ACU Main v4.00
	Library v1.15

**Cold Rollback**

Previous Package Version v 0	Antenna STABILIZERv-----	<span>Rollback</span>
	Antenna PCU v-----	
	ACU Main v-----	
Latest Package Version v131203	Antenna STABILIZERv4.00	<span>Rollback</span>
	Antenna PCU v4.00	
	ACU Main v4.00	

No.	Item	Description
①	Antenna Firmware Upgrade	Upgrade antenna and ACU firmware version.
②	New Antenna Firmware	Browse and select the firmware package file to upload and click Start Upload button.
③	Current Running Version	Display current firmware version (Antenna STABILIZER, Antenna PCU, ACU main, Library)
④	Cold Rollback	Display Previous/Latest Package version and rollback firmware to Previous or Latest version (Can do nothing while rollback is in progress)

### Upgrade procedures:

1. Select the upgrade package file.
2. Click on "Start Upload" button to transfer the Firmware package file ("\*.fwp") to iARM module.
3. After the package file is transferred, it'll show "upgrade from vx.xx Version to vx.xx Version". Enable the check box to select the firmware file that you wish to upgrade. To select all firmware files, click Select All Firmwares.
4. Click on "Start Upgrade" button.

- > Dash Board
- > Ship Setting
- > Antenna Setting
- > Tracking Setting
- > Diagnostic
- > Firmware&Configuration
- Antenna Firmware Upgrade
- Antenna Log
- Antenna Backup & Restore
- > Administration
  - Network Setting
  - SNMP Setting
  - User Management
  - iARM Upgrade
  - iARM Save & Reboot
  - Antenna Event Log

### Antenna Firmware Update

---

**The Firmware Package Update Ready**

Antenna STABILIZER	Update From v4.00 To v4.00	<input checked="" type="checkbox"/>
Antenna PCU	Update From v4.00 To v4.00	<input checked="" type="checkbox"/>
ACU MAIN	Update From v4.00 To v4.00	<input checked="" type="checkbox"/>

Start Update Select All Firmwares

**Firmware upgrade status page**

The screenshot shows a web interface for 'Antenna Firmware Update'. On the left is a navigation menu with categories: Dash Board, Ship Setting, Antenna Setting, Tracking Setting, Diagnostic, Firmware&Configuration (highlighted), and Administration. Under Firmware&Configuration, 'Antenna Firmware Upgrade' is selected. The main content area is titled 'Antenna Firmware Update' and contains a table titled 'The Firmware Package v131203 Update Status'.

The Firmware Package v131203 Update Status	
Antenna STABILIZER	Update From v4.00 To v4.00 20 %
Antenna PCU	Update From v4.00 To v4.00 Ready
ACU MAIN	Update From v4.00 To v4.00 Ready

At the bottom of the table area is a button labeled 'Back to main page'.

5. It'll display information about the upgrade process status on full screen.

**Upgrade process status page**

This screenshot shows the same 'Antenna Firmware Update' page as above, but with updated progress. The table 'The Firmware Package v131203 Update Status' now shows:

The Firmware Package v131203 Update Status	
Antenna STABILIZER	Update From v4.00 To v4.00 Success
Antenna PCU	Update From v4.00 To v4.00 Success
ACU MAIN	Update From v4.00 To v4.00 70 %

The 'Back to main page' button remains at the bottom.

6. If the firmware is successfully upgraded, it'll display "The firmware update is completed."

7. Click on "Back to main page" to go out of the screen.

To verify the upgraded firmware version, go to Dash Board > Software Information.

## Upgrade complete page

### The Firmware Package v131203 Upgrade Complete

---

Antenna STABILIZER "4.00" "Success"  
Antenna PCU "4.00" "Success"  
ACU MAIN "4.00" "Success"

The firmware update is completed.  
If you receive an fail message, please try again.  
Please refer to the User Guide if you have trouble connecting to the antenna.

[Back to main page](#)

**NOTE:** To roll back to the previous firmware package version or latest package version, select Rollback Upgrade menu on the Antenna Firmware Upgrade page.

### Antenna Log

Date/Time(UTC 00:00)	STAB	PCU	Main
Mon, 01 Jan 2007 00:32:13	4.00 Skip	4.00 Skip	4.00 Success

No.	Item	Description
①	Antenna Log	Displays antenna log data
②	GPS Log Option	Disable/Enable to save GPS information in the antenna log file.
③	Antenna Log Download	Download the log file. Select start download button to proceed.
④	Start Download	Download the antenna log information.
⑤	Antenna Firmware Log	Display log information of firmware upgrade.

### Log Download procedures:

1. Select 'Start Download' button.
2. To run Java applications you must have Java Runtime Environment (JRE) version 6.0 and above installed in your PC/ laptop when you access the antenna log page for first time. Click "Run" button on the popup message "The application's digital signature cannot be verified. Do you want to run the application? " to install the Applet. Refer to Appendix for Java Installation Instructions if the system does not display the popup message.

3. Select 'Browse' to browse the target directory of the antenna log file.
4. Select log period for file download.
  - Last 3 Months: download the antenna log information for the past three months.
  - Last 1 Month: download the antenna log information for the past one month.
  - Last 1 week: download the antenna log information for the past one week.
  - Last 1 Day: download the antenna log information for the past one day.
5. Select 'Download' to download the log file to the target directory according to the selected log period.

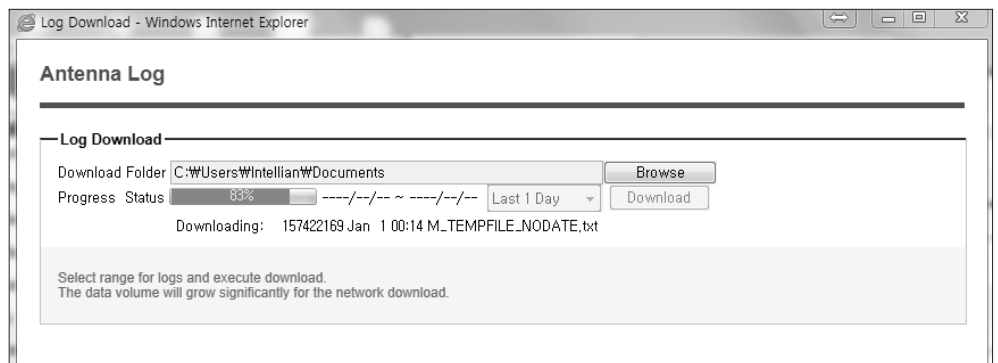

**NOTE:** In system, users can choose to Enable or Disable the GPS tracking function. Liability for information that is disclosed when GPS is enabled is solely the operators responsibility and it is up to the operator on whether or not to provide their GPS information to third parties. Any issues regarding safety and privacy when turning on the GPS function is solely up to the user. Intellian is not responsible for information that is disclosed when the GPS function is enabled.

## Antenna Backup & Restore

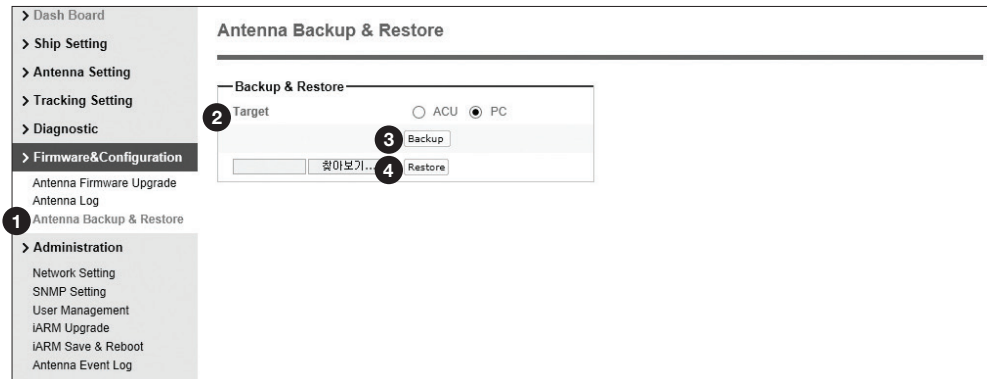

No.	Item	Description
①	Antenna Backup & Restore	Enter Backup & Restore page. (Setup mode is required)
②	Target	Backup antenna information to ACU/PC or restore antenna by using the saved information from ACU/PC.
③	Backup	Backup antenna information.
④	Restore	Restore antenna information.



# Administration

**WARNING:** Ensure to enter the SETUP mode before starting configuration. After completing the modification of settings, enter Save & Reboot page and click on “Save & Reboot” button. Without doing so, the modified settings will be lost.

## Network Setting

The screenshot shows the 'Network Setting' configuration page. On the left is a navigation menu with 'Administration' selected. The main content area is titled 'Network Setting' and contains four numbered sections:

- 1 Administration:** A sidebar menu with options like 'Network Setting', 'SNMP Setting', 'User Management', 'iARM Upgrade', 'iARM Save & Reboot', 'Antenna Event Log', 'Intellian Network Devices', 'Information', 'Control IP', 'Current IP', 'Refresh Rate', 'Refresh Disable', 'Idle Session Timeout', and 'Wifi'.
- 2 Network Configuration:**
  - Public Port Configuration:** IP Address (175.195.19.87), Subnet Mask (255.255.255.128), Gateway (175.195.19.126), DNS (168.126.63.1), NAT Routing (Enable).
  - Management Interface Configuration:** IP Address (192.168.2.1), Subnet Mask (255.255.255.0), Lease Start Address (192.168.2.2), Lease End Address (192.168.2.30), Lease Time (180 min).
  - WiFi Access Point Configuration:** SSID (intellian-T110W), Channel (5), Authentication Type (WPA2).
- 3 Sys Log Configuration:** Management Server (Disable), Server IP (192.168.1.1), UDP Port (514), Message Type (Diagnostic, Important, Periodic, Setting, Reserved), Syslog Target Level (LOG NOTICE).
- 4 Browser Configuration:** Refresh Rate (1 second), Refresh Disable Time (9 minutes).

No.	Item	Description
①	Networking Setting	Enter network setting page.

Modify ACU's internal IP address and click the Submit button. Go to the “Save & Reboot” page and click the Save & Reboot button to validate the changes.

② Network Configuration

• **Public Port Configuration**

- IP Address : Factory default (Primary:192.168.0.223)/ (Secondary:10.10.1.1).
- Subnet Mask : Factory default(255.255.255.0).
- Gateway : Factory default(192.168.0.254).
- DNS : Current default DNS Address is assigned to.
- NAT Routing : Enable/Disable NAT routing.

• **Management Interface Configuration.**

- IP Address : ACU front network port /Factory default(Primary:192.168.2.1)/(Secondary:10.10.10.1).
- Subnet Mask : Factory default(255.255.255.0).
- Lease Start Address : Lease IP address start range.
- Lease End Address : Lease IP address end range.
- Lease Time : Lease IP address update time.

---

• **Wi-Fi Access Point Configuration.**

- SSID : The SSID is the network name shared among all devices in a wireless network. The SSID must be identical for all devices in the wireless network. It is case-sensitive and must not exceed 32 alphanumeric characters, which may be any keyboard character. Make sure this setting is the same for all devices in your wireless network.
- Channel : Select an appropriate channel from the list provided to correspond with your network settings. All devices in your wireless network must use the same channel in order to function correctly. Try to avoid conflicts with other wireless networks by choosing a channel where the upper and lower three channels are not in use.
- Authentication Type : Module supports an authentication mode that the 802.11 device uses when it authenticates and associates with an access point or IBSS cell.
- Password : Wi-Fi access password.
- Max Stations : Setting max stations.

• **Network Service Configuration.**

- Telnet Service : Enable or disable telnet login support.
  - HTTPS Port : HTTPS port number.
- 

③ Sys Log Configuration

Set the Syslog Configuration.

Antenna makes log messages according to emergency level. When this function is enabled, your management server receives the log messages.

- Management Server : Syslog function enable/disable.
  - Server IP : Management server IP address.
  - UDP Port : Management port.
  - Message Type : Select message type(Intellian message level) to send management server (The lower level is more emergency).
  - Syslog Target Level : If you select this target level, the Server receives log message equal or less than this level.
-

---

④ Browser Configuration

Set the refresh rate and the refresh disable time.

- Refresh Rate : Set the browser refresh rate (Default 1 seconds. Range 1~99).
- Refresh Disable Time : Set the browser idle timeout(Default:9 minutes. Range 0~9).

If you tick the checkbox, you can use this function.

---

### SNMP Setting

No.	Item	Description
①	SNMP Setting	Display and Set SNMP configuration.
②	SNMP V1/V2 Status	Set SNMP mode(Use Attribution Disable, Read Only or Read Write).
③	V1/V2 Community Name	Set SNMP V2 community name.
④	V3 Authentication Type	Set SNMP V3 authentication mode.
⑤	V3 Authentication Encoding	Set SNMP V3 authentication encoding.
⑥	V3 Username	Set the V3 username and password of the SNMP Agent. The password is at least 8 character string.
⑦	V3 Private Encoding	Set SNMP V3 Private Encoding.
⑧	V3 Private Password	Set the V3 password of the SNMP Agent. The Password is at least character string.
⑨	TRAP IP/Port	Set the V3 password of the SNMP Agent. The Password is at least character string.
⑩	TRAP Parameter	Set the SNMP trap specific parameter.

## User Management

No.	Item	Description
①	User Management	Change login ID and Password to access the Web M&C. This setting can be also accessed by 'Account' icon on the top menu.
②	Change ID & Password	<p>Change your login ID (username) and password.</p> <ul style="list-style-type: none"> <li>• Change ID : Enter your current login ID (username) and new login ID. Click the Submit button to validate the changes that are made to the login ID.</li> <li>• Change Password : Enter your current login password and new login password. Click the Submit button to validate the changes that are made to the login password.</li> </ul>
③	Change User Settings	<p>Change User Password Expire in days and Idle session timeout.</p> <ul style="list-style-type: none"> <li>• Password Expire Timeout : Set password expire in days.</li> <li>• Idle Session Timeout : Set for Console and for Network Timeout.</li> </ul>

### iARM Upgrade

No.	Item	Description
①	iARM Upgrade	Upgrade the firmware of iARM module.
②	New iARM Firmware	Select a new firmware file and click Start Update button to upgrade the firmware.
③	Bootstrap /Bootloader	Displays current bootstrap and bootloader version.
④	Kernel /File System	ACU has 3 storage parts sys0, sys1, Factory Default Display kernel and file system version and current activated part Information.

#### iARM firmware upgrade procedures:

1. Click on “Browse” button to select the iARM firmware file (.tgz) that you wish to upgrade.
2. Click on “Start Update” button to update the iARM firmware. Wait until the page is loaded.
3. It'll inform you that the firmware is being uploaded.

**Firmware upload in progress**

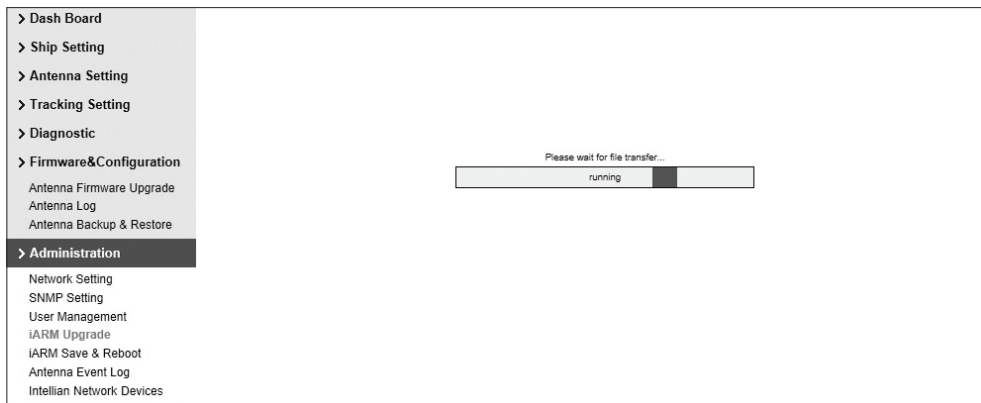

4. Do not turn off the ACU power if the firmware upgrade page is displayed.

**Firmware upgrade in progress**

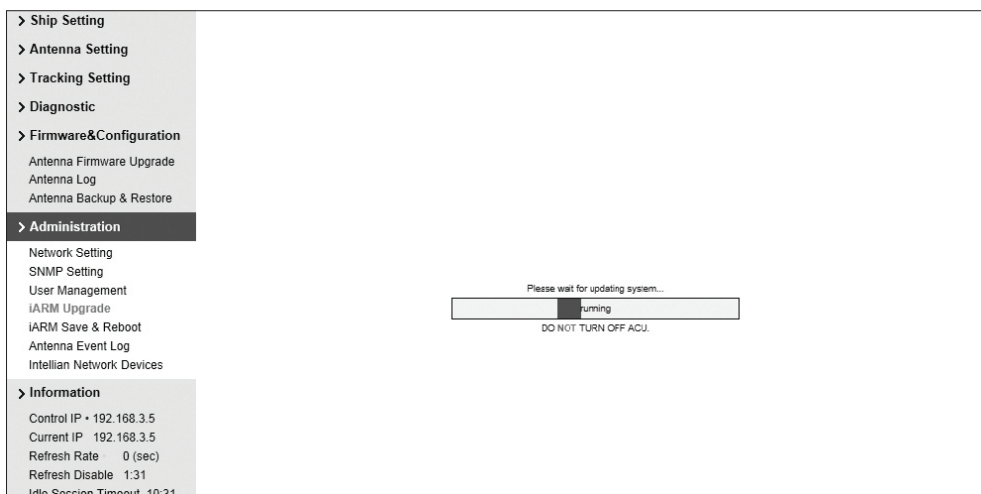

5. It'll take around 2 minutes to complete the firmware upgrade. Once the upgrade is completed, the system will reboot automatically.

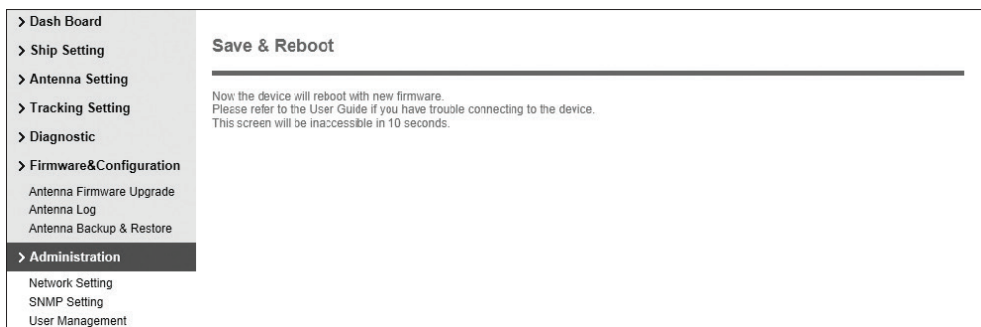

6. The connection will be disconnected during the reboot. It'll take around 30 seconds to reboot the iARM module and get the connection back again. (Disconnection message may vary depending on the web browsers.)

## iARM Save & Reboot

The screenshot shows the 'iARM Save & Reboot' configuration page. On the left is a navigation sidebar with categories: Dash Board, Ship Setting, Antenna Setting, Tracking Setting, Diagnostic, Firmware&Configuration, Administration (highlighted), and Information. Under Administration, 'iARM Save & Reboot' is marked with a circled '1'. The main content area is titled 'iARM Save & Reboot' and contains two sections: '2 Save & Reboot' with a 'Save & Reboot' button and '3 Reboot without Saving' with a 'Reboot Only' button.

No.	Item	Description
①	iARM Save & Reboot	Save settings to the ACU and reboot or reboot the system without saving.
②	Save & Reboot	Save the modified settings and reboot the system. Click Save & Reboot button.
③	Reboot without Saving	Reboot the system without saving the modified settings. Click Reboot Only button.



## Antenna Event Log

- > Dash Board
- > Ship Setting
- > Antenna Setting
- > Tracking Setting
- > Diagnostic
- > Firmware&Configuration
  - Antenna Firmware Upgrade
  - Antenna Log
  - Antenna Backup & Restore
- > Administration
  - Network Setting
  - SNMP Setting
  - User Management
  - iARM Upgrade
  - iARM Save & Reboot
  - Antenna Event Log
  - Intellian Network Devices
- > Information
  - Control IP • 175.195.19.5
  - Current IP 175.195.19.5
  - Refresh Rate • 1 (sec)
  - Refresh Disable 8:37
  - Idle Session Timeout 19:38
  - Wifi

### Antenna Event Log

**2** Query Filter

Severity:  Category:

Time Frame:  Sorting Order:  Descending  Ascending

**3** Event Log

Date/Time(UTC)	Severity	Category	Log
2007-01-01 03:31:31	Normal	Access	Remote Control Login through WEB from 175.195.19.5 using ID intellian
2007-01-01 03:26:27	Normal	Access	Remote Login through CLI from 175.195.19.5 using ID guest
2007-01-01 03:24:05	Normal	Access	Remote Control Login through WEB from 175.195.19.5 using ID intellian
2007-01-01 02:09:26	Normal	Access	Remote Control Login through WEB from 175.195.19.5 using ID intellian
2007-01-01 00:54:31	Normal	Access	Remote Control Login through WEB from 175.195.19.5 using ID intellian
2007-01-01 00:40:31	Normal	Access	Remote Control Login through WEB from 175.195.19.5 using ID intellian
2007-01-01 00:39:39	Normal	Access	Remote Control Login through WEB from 175.195.19.5 using ID intellian
2007-01-01 00:36:17	Normal	Access	Remote Control Login through WEB from 175.195.19.5 using ID intellian
2007-01-01 00:36:08	Normal	System	BIM successfully booted up in SY50
2007-01-01 00:36:06	Major	System	Skipped Receiveing /tmp/mmcblk0p2/event_log.db : /tmp/mmcblk0p2 is not mounted
2007-01-01 00:30:27	Normal	Access	Remote Control Login through WEB from 175.195.19.5 using ID intellian
2007-01-01 00:26:14	Normal	Access	Remote Control Login through WEB from 175.195.19.5 using ID intellian
2007-01-01 00:22:04	Normal	Access	Remote Control Login through PC Client from ipv4_top:192.168.2.2:59681 using ID intellian
2007-01-01 00:20:33	Normal	System	BIM successfully booted up in SY50
2007-01-01 00:20:31	Major	System	Skipped Receiveing /tmp/mmcblk0p2/event_log.db : /tmp/mmcblk0p2 is not mounted
2007-01-01 00:18:48	Normal	Access	Remote Control Login through WEB from 192.168.2.2 using ID intellian
2007-01-01 00:16:43	Normal	System	BIM successfully booted up in SY50
2007-01-01 00:16:41	Major	System	Skipped Receiveing /tmp/mmcblk0p2/event_log.db : /tmp/mmcblk0p2 is not mounted
2007-01-01 00:12:45	Normal	System	BIM successfully booted up in SY50
2007-01-01 00:12:43	Major	System	Skipped Receiveing /tmp/mmcblk0p2/event_log.db : /tmp/mmcblk0p2 is not mounted
2007-01-01 00:04:57	Normal	System	BIM successfully booted up in SY50
2007-01-01 00:04:55	Normal	System	BIM successfully booted up in SY50
2007-01-01 00:04:45	Normal	System	BIM successfully booted up in SY50
2007-01-01 00:03:14	Normal	System	BIM successfully booted up in SY50
2007-01-01 00:03:07	Normal	System	BIM successfully booted up in SY50
2007-01-01 00:03:06	Normal	System	BIM successfully booted up in SY50
2007-01-01 00:02:39	Normal	System	BIM successfully booted up in SY50
2007-01-01 00:01:05	Normal	Access	Remote Login through CLI from 127.0.0.1 using ID intellian
2007-01-01 00:00:40	Normal	System	BIM successfully booted up in SY50
2007-01-01 00:00:38	Normal	System	BIM successfully booted up in SY50
2007-01-01 00:00:36	Normal	System	BIM successfully booted up in SY50
2007-01-01 00:00:36	Major	System	Recovered /flash/event_log.db with SD Card DB
2007-01-01 00:00:34	Normal	System	BIM successfully booted up in SY50
2007-01-01 00:00:32	Major	System	Recovered /flash/event_log.db with SD Card DB
2007-01-01 00:00:30	Major	System	Recovered /flash/event_log.db with SD Card DB

No.	Item	Description
①	Antenna Event Log	Displays user's log information (Data/Time, Login ID and IP)
②	Query Filter	Set the Log message option. <ul style="list-style-type: none"> <li>Severity : Set urgency level.</li> <li>Category : Set target that caused the message.</li> <li>Time Frame : Set time limit that you want to show.</li> <li>Sorting Order : Sorting based on date(descending or ascending).</li> </ul>
③	Event Log	Displays log information (Date/Time, Severity, Category, Log). <ul style="list-style-type: none"> <li>Save Event Log : Save log message to your PC</li> </ul>

137

## Intellian Network Devices

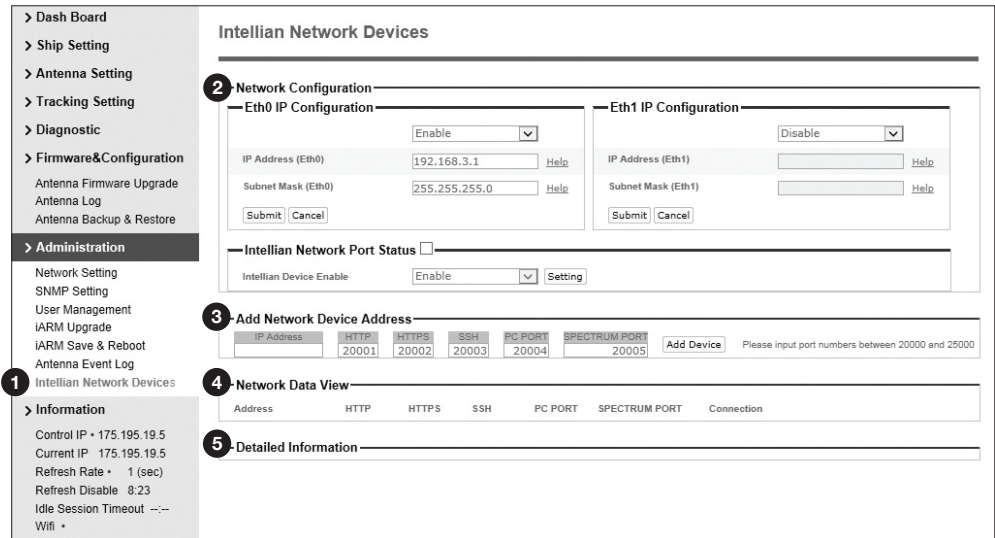

No.	Item	Description
①	Intellian Network Devices	Add up to 8 network devices and enable to monitor real time information of the connected device.
②	Network Configuration	<ul style="list-style-type: none"> <li>Eth0 IP Configuration : ACU network Eth0 IP and subnet mask setting.</li> <li>Eth1 IP Configuration : ACU network Eth1 IP and subnet mask setting.</li> <li>Intellian Network Port Status : not used on t-series.</li> </ul>
③	Add Network Device Address	<ul style="list-style-type: none"> <li>IP Address : IP address of the device to be monitored.</li> <li>HTTP, HTTPS, SSH : Set port number(These port numbers will be matched the http, https or SSH port number of each device).</li> </ul>
④	Network Data View	<p>Displays the setting information of the added device (IP address, http, https, SSH port number, current connection).</p> <p>If you click the http/https port number of each device, then you can connect to the device's web page. If you click Delete Device button, then you can't see its information.</p>
⑤	Detailed Information	Displays the information of each device. (Updated every 3 second).

# Technical Specification

<b>General</b>	
Approvals	
CE – conforms to	EU Directive 89/336/EEC
FCC – verified to	CFR47: Part 15
<b>Dimensions</b>	
Satellite antenna unit	113cm x 121cm (44.6" x 47.5")
Antenna dish diameter	85cm (33.5")
Antenna control unit	43.1cm x 38cm x 4.4cm (17" x 15" x 1.7")
<b>Weight</b>	
Satellite antenna unit	82.2 kg (181.2 lbs)
Antenna control unit	3.5kg (7.7lbs)
<b>Environmental</b>	
Operating temp. range	-25°C to +55°C (-13°F to +131°F)
Storage temp. range	-40°C to + 80°C (-40°F to + 176°F)
Humidity limit	95% R.H
Power requirements	110/220V AC
Power consumption	Typ. 50W, Max. 100W
<b>Antenna System Performance</b>	
Frequency	Ku-band(10.7 to 12.75 GHz)
Minimum EIRP	44 dBW
Azimuth range	680°
Elevation range	-15° ~ +110°
Cross-level range	±30°
Roll / Pitch / Yaw	±25° / ±15° / ±8° @ 6 sec period
Turning rate	Up to 12°/sec and 5°/sec <sup>2</sup>

## Warranty

Intellian systems are warranted against defects in parts and workmanship, these warranties cover THREE (3) YEAR of parts and TWO (2) YEAR of factory repair labor to return the system to its original operational specification.

Warranty periods commence from the date of shipment from Intellian facility, or date of installation which is come sooner. Providing maximum 6 months Warranty additionally if submission of authorized form which is described installation occurs within 6 months from the shipment date.

Intellian Technologies warranty does not apply to product that has been damaged and subjected to accident, abuse, misuse, non-authorized modification, incorrect and/or non-authorized service, or to a product on which the serial number has been altered, mutilated or removed. Intellian Technologies, will (at its sole discretion) repair or replace during the warranty period any product which is proven to be defective in materials or workmanship, in accordance with the relevant product warranty policy. All products returned to Intellian Technologies, during the warranty period must be accompanied by a Service Case reference number issued by the dealer/distributor from Intellian Technologies, and (where applicable) a copy of the purchase receipt as a proof of purchase date, prior to shipment. Alternatively, you may bring the product to an authorized Intellian Technologies, dealer/distributor for repair.

# Appendix: Library Upgrade Guide

The purpose of this section is to provide you with the necessary information to properly upgrade the Library version. Intellian recommends reviewing this guide thoroughly to perform the Library function successfully.

## Step 1

Open a web browser on the PC and type the default IP address (192.168.1.2) to access the Aptus web page. Login to the “Aptus Web” page by typing the User Name and Password on the Aptus Web page.

## Step 2

Before beginning Library Upgrade, check the “Current Library Version” on the “Software Information” section of the main page.

Then click “Firmware & Configuration” → “Antenna Firmware Upgrade” on the left side of the main page to display “Antenna Firmware Update” page.

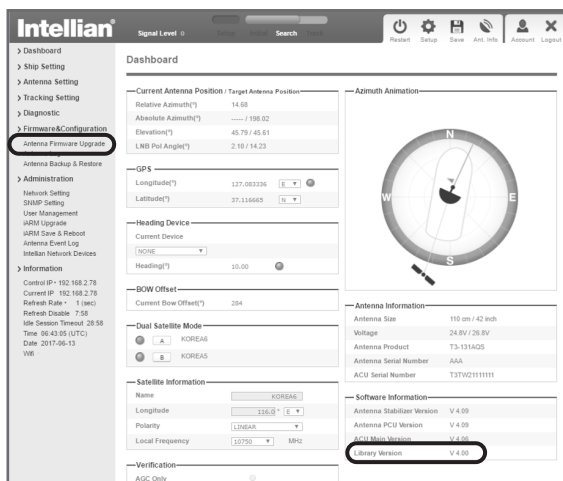

## Step 3

Click the “Browse” button on the “New Antenna Firmware” section to download the specific library file.

**NOTE.** Be sure to select “Manual Upgrade” in the drop-down list to specify the Upgrade Method.

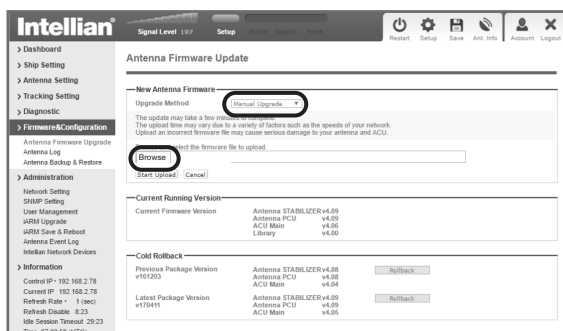

**Step 4**

After clicking the “Browse” button, the Open File dialog box will pop up. Select the latest approved version of the Library file for your ACU to download.

**NOTE.**

- Be sure the Library file is the latest approved version and correct model name.
- If you have any problems while performing this step, contact the Intellian service team for support.

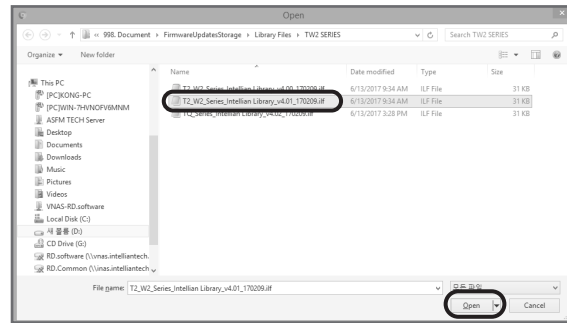

**Step 5**

Click the “Start Update” button to move to the “The Library Update Ready” page.

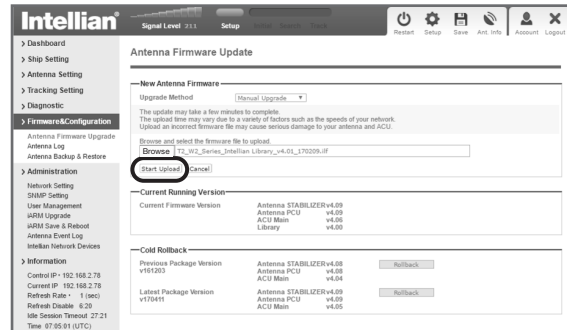

**Step 6**

Check the current Library version and the latest Library version. Click the “Start Update” button to update the Library file.

**NOTE.** Be sure to select the checkbox before clicking the “Start Update” button.

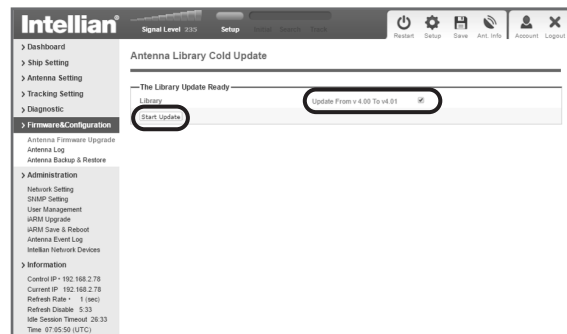

**Step 7**

The "Upgrade is running! We move to upgrade status monitor page." message will appear indicating the upgrade has started. Click "OK" button.

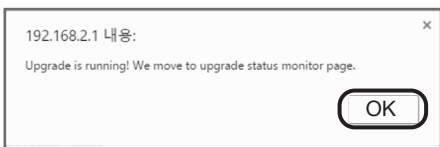

**Step 8**

After the upload is complete and the Library upgrade confirmation message is displayed, confirm the "Library vx.xx Success" message and the ACU will automatically restart. Click the "Back to main page" button to return to the main page.



**Step 9**

Check the "Upgraded Library Version" on the "Software Information" section of the main page.

